

2023



Campagnolo

DREAM BIGGER

ENG - 6/2022



**TADEJ POGAČAR (UAE TEAM EMIRATES)
SECOND PLACE AT THE 2022 TOUR DE FRANCE AND
WINNER OF THE 2020 AND 2021 TOUR DE FRANCE
WITH CAMPAGNOLO GROUPSET AND WHEELS**

INDEX

TEAMS 2022	4
CAMPAGNOLO® E-STORE	6

GROUPSETS

GRAVEL GROUPSETS		8
EKAR™	1x13 Speed Disc Brake	10 - 19
ROAD GROUPSETS		20
GROUPSET TECHNOLOGIES		22 - 71
SUPER RECORD™ EPS™	12x2 Speed Disc Brake - Rim Brake	72 - 75
SUPER RECORD™	12x2 Speed Disc Brake - Rim Brake	76 - 79
RECORD™	12x2 Speed Disc Brake - Rim Brake	80 - 83
CHORUS™	12x2 Speed Disc Brake - Rim Brake	84 - 87
CENTAUR™	11x2 Speed Rim Brake	88 - 89

WHEELS

WHEEL TECHNOLOGIES		92 - 115
PERFORMANCE/AERO CARBON WHEELS		116
BORA™ ULTRA WTO TT	Disc Brake	119
BORA™ ULTRA WTO 80	Disc Brake	120
BORA™ ULTRA WTO 60	Disc Brake	121
BORA™ ULTRA WTO 45	Disc Brake	122
BORA™ ULTRA WTO 33	Disc Brake	123
BORA™ ULTRA TT	Rim Brake	124
BORA™ WTO 77	Rim Brake	125
BORA™ WTO 60	Disc Brake - Rim Brake	126 - 127
BORA™ WTO 45	Disc Brake - Rim Brake	128 - 129
BORA™ WTO 33	Disc Brake - Rim Brake	130 - 131
GRAVEL CARBON WHEELS		132
LEVANTE™	Disc Brake	134
ENDURANCE CARBON WHEELS		136
SHAMAL™ CARBON	Disc Brake	138
ALUMINIUM WHEELS		140
SHAMAL™ ULTRA™	Rim Brake	141
ZONDA™	Disc Brake - Rim Brake	142-143
SCIROCCO™	Disc Brake - Rim Brake	144- 145
CALIMA™	Rim Brake	146

TRIATHLON / TT

COMPONENTS	150
BORA™ ULTRA WTO TT	Disc Brake 152
SUGGESTED WHEELS	153

PISTA

WHEELS	154
GIBLI™	156
BORA™ ULTRA™ 80	157

TECH DATA

GROUPSETS	159
WHEELS	170
SERVICE CENTER - SALES NETWORK	176



THE BEST TEAMS CHOOSE CAMPAGNOLO®

For over 80 years, the quality and precision of Campagnolo® products have accompanied big names like Coppi, Gimondi, Merckx and Indurain in their many victories in the past.

Still today, our company is right there alongside the stars of modern cycling such as Tadej Pogacar, Caleb Ewan and Diego Ulissi, using the components and wheels of our historic brand. Again in 2022, the best cyclists will be able to count on the excellent quality and top-level performance that have always made our Italian-brand products stand out.

Thanks to the contribution in terms of technology, reliability and performance that our components make in achieving victory in all classes of race, many teams on different levels choose Campagnolo® for their racing season.

UAE TEAM EMIRATES



2022 UCI WORLD TEAMS

AG2R

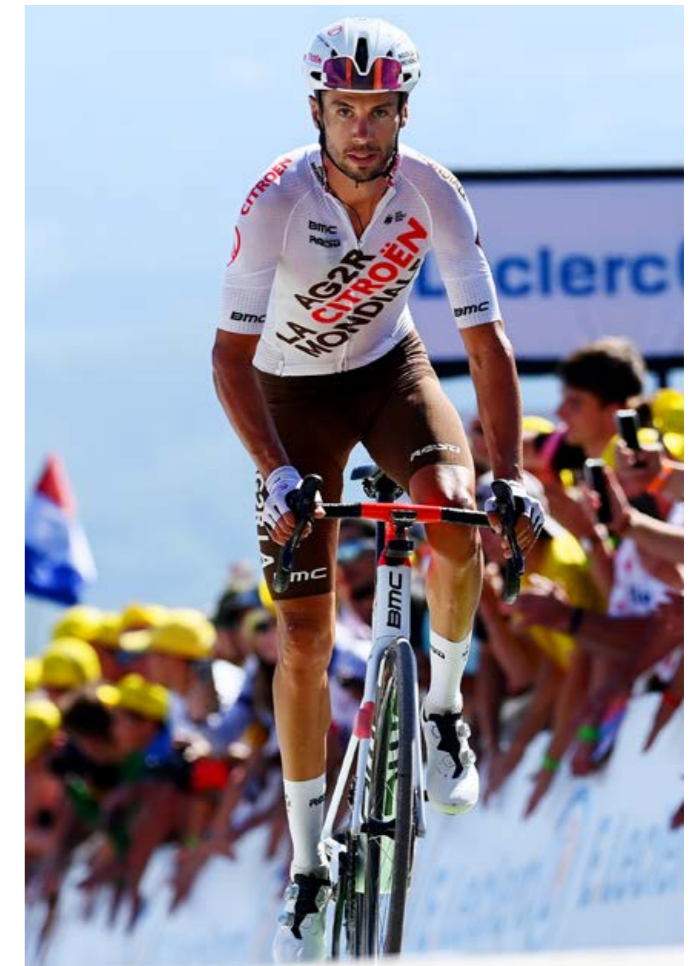

COFIDIS

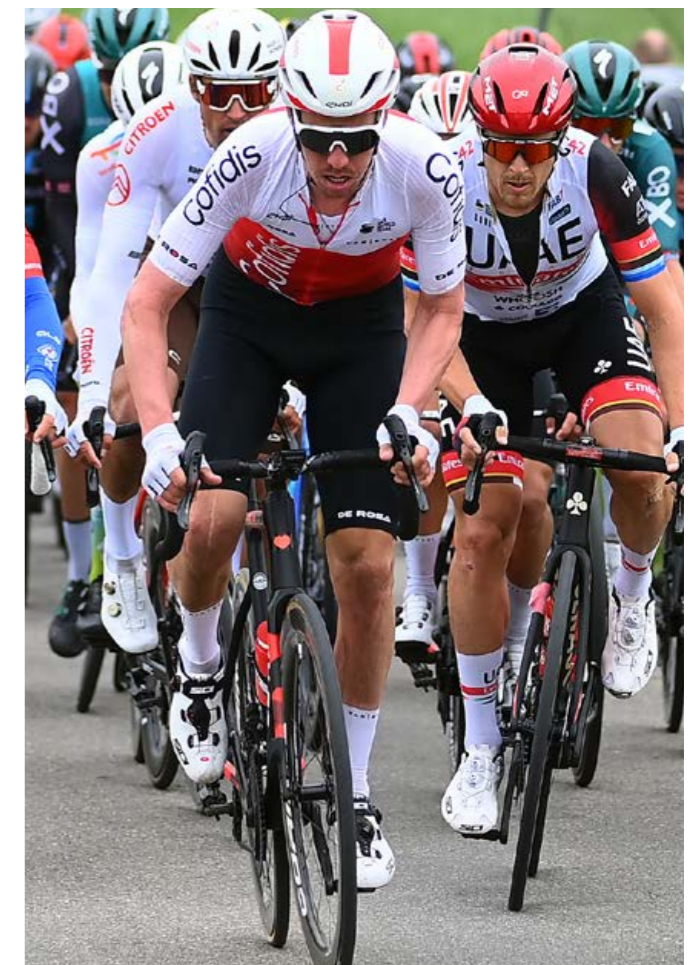

As the hashtag says, #thoseintheknow choose Campagnolo® and those that choose Campagnolo® do so not only because they are sure of getting their hands on some of the most performance oriented, reliable and sophisticated componentry for cycling available but also due to what Campagnolo® represents. Products made with passion that exude a pure and authentic cycling tradition will give a definite race winning advantage but also communicate that the rider is one who takes a great deal of pride in his cycling and expects something more from his time in the saddle.

GRAVEL GROUPSETS

Campagnolo® presents EKAR™,
the next-generation 1x13 gravel drivetrain.





**The world's lightest gravel groupset (2.385 g):
reliable, durable & fast.
Born hard so you can ride easy.**

Born on Mt Ekar: just as Campagnolo's ground-breaking first quick release lever can trace its origins to the Passo Croce D'Aune climb, **the innovative new gravel-focused Ekar™ groupset was born on another cima local to today's Campagnolo headquarters: Ekar.**

With its asphalt giving way to tracks and trails, climbs and descents present surfaces and characters that evolve season-by-season and change, ride-by-ride, Ekar™ epitomises the special challenges of Italian gravel. But Mt Ekar's influence goes beyond physicality; **it represents the spirit of riding gravel, of adventure, and of freedom.**

**Ekar™ delivers 1x13 transmission
the way it should be:
wide range, close ratio and no compromise**

Thanks to a 9T sprocket, Ekar's unique and innovative gravel-specific 1x13 drivetrain delivers a full range of gear ratios with smooth, natural gear progressions for the perfect cadence, whatever your speed, and whatever your style of gravel riding.

With four chainring options – 38, 40, 42 and 44T – and a choice of three cassettes – 9-36T, 9-42T and 10-44T – **Ekar is ready for however you ride and wherever your adventures take you!**



Ekar™ Rear Derailleur

The Ekar™ rear derailleur's all-new design has been created specifically for gravel.

The highly effective 1x13-speed drivetrain has a full gearing range with short, evenly spaced shifts for well-maintained cadence levels, with the strong and durable yet lightweight and efficient derailleur at its heart.

The combination of more than 70 moving parts lovingly crafted in carbon fiber, carbon-reinforced polyamide and anodised 7075 and 6082 alloys – with stainless steel bolts – exceed the demands of all-road riding to **combine quick, precise, reliable shifting with high chain security, and the toughness** that only comes by being born on Mt Ekar.



FEATURES & BENEFITS

New design for 1x13-speed system – gravel-orientated performance & build
2D parallelogram trajectory – precise mechanical movement for 13 sprockets

High grade polymer pulley wheels (12T upper, 14T lower) – smooth chain running & secure retention

Carbon fiber-reinforced polyamide & anodised 7075 and 6082 alloys – for light weight, strength & durability

Stainless steel bolts – for strength & long-term resilience on gravel

Clutch lock – for easy wheel removal

One derailleur fits all three cassette options – easy to switch for gearing changes

Weight: 275 g



Ekar™ Ergopower™ controls

For the new gravel-focused Ekar™ drivetrain design, we've taken the best of classic Campagnolo® controls technology and adapted it for the most pragmatic, natural gravel-riding experience.

They're the most comfortable shaped lever and hoods, with easily-adjusted reach size giving you precise, quick shifting and positive engagement – every time, at every speed, on every surface.

A new Lever 3 design means it's easy and reliable to activate from the drops. Ekar™ Ergopower's all-new surface is easy to grip and easy to clean, and there's Campagnolo's signature quick 3-gear up-shift with Ultra-Shift™ – features that all gravel riders will appreciate. Insight and passion from its birth at Mt Ekar to wherever you choose to ride!



FEATURES & BENEFITS

Comfortable support - Vari-Cushion™ hood provides comfortable, safe grip in any riding position and any off-road conditions
Precise, quick shifting – One-Lever-One-Action and positive engagement with the efficient 1x13-speed Ekar drivetrain means a perfect change every time

New Lever 3 design – easy to activate from the tops

Multiple action – up-shift 3 gears with Ultra-Shift™

Ergonomic adjustable reach – to suit any hand or finger size

Weight: 420 g

Ekar™ Crankset

The 1x crankset is a crucial element in Campagnolo's gravel-specific Ekar™ drivetrain design.

Lightweight, secure and simple up front, with no wasted overlapping gears or unnecessary moving parts to collect trail dirt – one chainring and no front mech is the way to go, whatever your off-road ambitions!

But behind that apparent simplicity is a design to die for. The unidirectional carbon fiber cranks feature a strong, durable 630-grade steel alloy crank axle – following the maxim of smartly mating strength and light weight that is employed across the Ekar™ groupset.

New Pro-Tech™ technology joins the two semi-axles inside the BB while oversized stainless steel bearings sit outside the shell, for smoothness, strength and easy access.

Four ring options 38, 40, 42 and 44-teeth – combine with cassette options to ensure there's a gear range perfect for every rider and every ride.



FEATURES & BENEFITS

Lightweight, efficient, secure 1x Ekar system – perfect for gravel riding and racing
2-piece cranks: Ultra-Torque™ 630 steel axle & UD carbon arms – strong and lightweight
4 ring options – Adventure (38T), Pure Gravel (40T), Fast Gravel (42T), Gravel Race (44T)

Narrow-wide tooth design – efficient drive & maximum chain security
ProTech™ strong, efficient, self-aligning Hirth joint semi-axles

Easy access to external crank bearings

Easily interchangeable alloy rings – no need to disassemble crank

4 crank arm lengths: 165, 170, 172,5 e 175 mm

Narrow Q-factor: 145,5 mm

Technology: Pro-Tech™

Weight: 615 g (172.5mm, 38T)



Ekar™ Pro-Tech™ Bottom Bracket

From the Ekar™ 1x13 drivetrain's very first days of inspiration and conception at its spiritual home, Mt Ekar, we knew **the performance and protection of the bottom bracket was another crucial element in the lifetime of smooth running, efficiency and longevity for our new gravel-specific groupset.**

So we made **the new Pro-Tech™ system: a gravel-orientated development from the innovative Campagnolo® Ultra-Torque™ technology**, Pro-Tech's two integrated semi-axles meet at a central Hirth joint where self-centring and self-aligning teeth create a positive, balanced drive, increase efficiency and save weight, while large BB bearings run smoothly inside the crank.

It's all protected by a patented external sealing ring and strong fiberglass-polyamide tube that resist harmful ingress of water, mud and grit that threaten in the most challenging gravel routes.

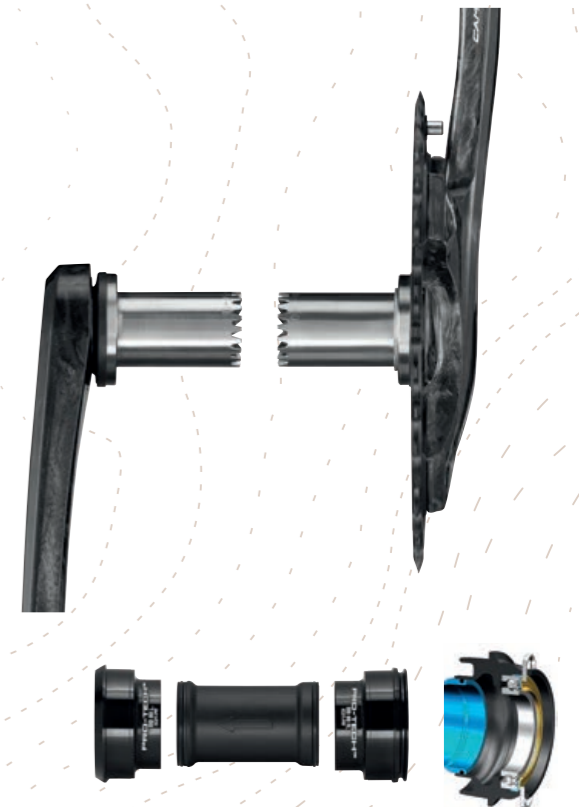

FEATURES & BENEFITS

Designed specifically for gravel riding and racing – protected from harmful ingress of water, mud & grit
ProTech™ – a patented external sealing ring & strong fiberglass-polyamide tube
Large, protected external stainless steel bearings attach directly to crank arms –

for smooth, fluid performance and easy maintenance

Full compatibility – all threaded and Pressfit standards:
 BSA, ITA, BB86, BB30, BB30A, BB386, PF30, BB RIGHT, T47

Weight: 50 g



Ekar™ Cassette

Campagnolo's considerations behind the gearing ratios and cadence-managing shifts is fundamental to the design of Ekar's gravel-specific cassettes. And their tough, durable yet efficient build matches the clever maths perfectly to life on the gravel trails of Italy's Mt Ekar, and wherever in the world your adventures will take you!

13 sprockets make the logic of the 1x system possible. And what makes it work so perfectly for all-road riding, is our introduction of the 9-tooth cog. It means the wide range of gear ratios is not just possible, but that all the **natural, progressive cadence-matching shifts create a uniquely satisfying ride.**

With the new, lightweight and versatile **N3W™ driver body** (further details on p. 106) and a 2-block design to combine steel strength and alloy weight-saving, the Ekar™ cassettes come with **three gearing options – 9-36, 9-42 and 10-44 – ready for every specialism of gravel riding and every kind of rider.**



FEATURES & BENEFITS

- 13-speed** – full range to match or exceed any 2x systems, with no wastage
- 9-tooth sprocket** – allows full range with zero drop in efficiency
- Compact** – narrow design with quick changes, lightweight, improved chain security
- Durable** – tough materials and design, with no weight penalty
- Combinations: Endurance:** 9-36T (9-10-11-12-13-14-16-18-20-23-27-31-36)
- Gravel Race:** 9-42T (9-10-11-12-13-14-16-18-21-25-30-36-42)
- Gravel Adventure:** 10-44T (10-11-12-13-14-15-17-20-23-27-32-38-44)
- Closer low gear spacing** – creating natural cadence progression
- Wider higher gear spacing** – creating top-end speed options
- 2-piece block** – blends strength of steel with light weight of alloy
- Works with new N3W™ driver body** – for great versatility and full compatibility
- Technology:** N3W™ (further details on p. 106)
- Weight:** 340 gr (9-36T)/ 390 gr (9-42T)/415 gr (10-44T)



Ekar™ Chain

A drivetrain – in fact a bike – is nothing without a chain to make it all work!

And in our ground-up design of the gravel-specific 1x13 Ekar™ drivetrain, we kept that fundamental component front and center of our focus.

But we didn't just want to chain to work – **we knew it had to be a vital element in operating effectively and reliably in the toughest environments gravel riding can throw at you!**

The new Nickel-Teflon treated C13 chain is designed specifically to work efficiently and securely with the narrow-wide 13-sprocket system.

Despite being our narrowest ever chain it's also strong, light, durable and amazingly efficient.

The Ekar™ C13 chain comes in two options: Classic Pin and C-Link™ to suit every kind of gravel rider, the world over.



FEATURES & BENEFITS

- New C13 chain** – developed specifically for Ekar 1x13-speed gravel system
- Wide-narrow teeth design** – for efficient drive, smooth shifts & high security
- Narrow profile** – light weight, strong & efficient
- Strong, durable, links** – with different grades of steel & coatings for strength and to withstand wear
- Unique ultrasound bath lubrication impregnation system** – for long-life efficiency
- Classic Pin and C-Link™ options** – options for every kind of gravel rider
- Weight:** 242 gr (117 links / C-Link) / 242 gr (118 links / Pin)



Ekar™ Brakes

Stopping fast helps you ride fast, and knowing that your brakes are powerful yet sensitive, with a uniquely 'real' feel is a priceless riding confidence boost.

Ekar brakes' trusted modulation and progressive feel are perfect for all-road control, whatever your style and whatever the conditions.

Paired with Ekar's Ergopower controls, we shared the best technology of Campagnolo's high-performance hydraulic system's internals for the Ekar brakes – and fine-tuned them for gravel riding.

FEATURES & BENEFITS
 Hydraulic system's internals are shared with Campagnolo's high-performance ranges – for proven performance
 Trusted modulation and progressive feel – perfect for all-road control
DB310 pads unique organic compound – high braking performance & improved wear resistance in wet or dry conditions
Strong, durable & light
Weight: 110 gr front (adapter incl.) 95 gr rear



Ekar™ Rotors

Tempered stainless steel rotors are strong, light and corrosion-resistant, with a choice of 140 and 160mm discs and the organic compound DB310 pads providing **power, performance and durability come sun or rain, dust, dirt and demonic descents.**

VANTAGGI & CARATTERISTICHE
 Trusted modulation and progressive feel – perfect for all-road control
140 and 160mm rotors – to suit your riding style and bike
Weight: 157 gr (160mm) / 123 gr (140mm)

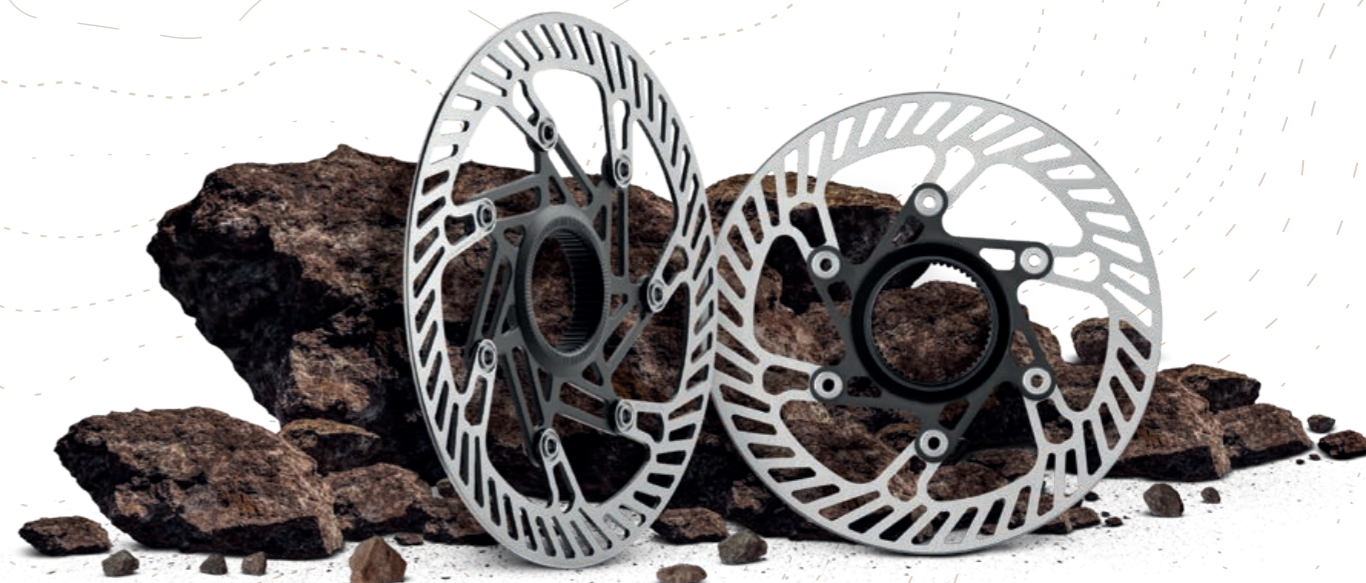

GROUPSETS FOR RACING BICYCLES

GROUPSET TECHNOLOGIES

SUPER RECORD™ EPS™	12x2 Speed	Disc Brake - Rim Brake	22 - 71
SUPER RECORD™	12x2 Speed	Disc Brake - Rim Brake	72 - 75
RECORD™	12x2 Speed	Disc Brake - Rim Brake	76 - 79
CHORUS™	12x2 Speed	Disc Brake - Rim Brake	80 - 83
CENTAUR™	11x2 Speed	Disc Brake - Rim Brake	84 - 87
		Rim Brake	88 - 89



12x2 SPEED

Campagnolo® presents the next step towards perfecting movement:
the 12x2 Speed groupsets.

A historic milestone indeed as Campagnolo proudly presents a performance solution that improves upon every aspect of the groupset: ergonomics, performance, precision, reliability and design.





POWER UNIT V4

V4 Power Unit

New Design, New Possibilities



Longer and Longer Lasting:

10% longer battery life



Slim structure compatible with nearly all frames

Seat post adaptor allows for easy internal mounting



INTERFACE V4

V4 Interface External version

Same aerodynamic design, new 12 speed specific intelligence

Command center

Transmission control but also BLE and ANT+ antennae for complete interaction with external devices



V4 Interface Internal version:

Option 1 - BAR END



V4 Interface Internal version:

Option 2: FRAME

CABLES AND HOUSING

ERGOPOWER EPS

New transmission

offers some of the smoothest and most effortless shifting ever produced by Campagnolo



Improved and customizable ergonomics

New cables and housing drastically reduce friction



New hood design:

Vari Cushion Technology

Maintain exceptional smoothness far beyond those of the competition

THE MAXIMUM SMOOTHNESS

maximum performance longevity



Upgraded brake lever

Result of meticulous hand movement studies (double curve brake lever, new form outward curve).

ERGOPOWER™

SUPER RECORD™ EPS

SUPER RECORD™ EPS

ERGOPOWER™

Larger thumb shifting lever



Braking lever pivot aligned with slant of Ergopower

Better, more efficient power transfer requiring less energy from riders hand

Upshifting lever enlarged



One lever
One action

Upshifting lever incorporated into brake lever



Multi-Shift mechanism maintained

Upshift up to 12 sprockets

Downshift up to 12 sprockets

ERGOPOWER™

SUPER RECORD™ EPS™

SUPER RECORD™ EPS™

ERGOPOWER™ DB

Solid, robust and reliable internal design

New 12 speed shifting, same internals that have proven worthy since EPS's launch

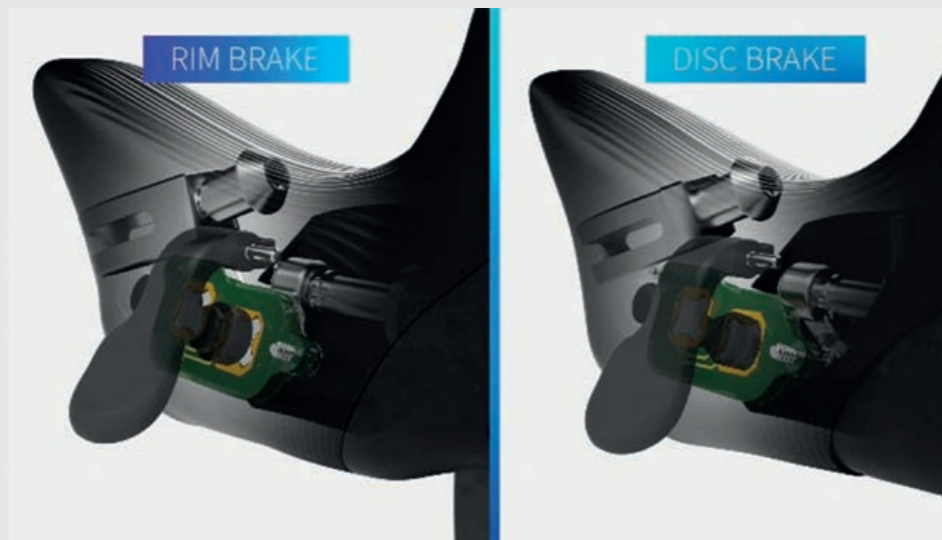

ERGOPOWER EPS DB

Master cylinder: low profile made possible via fantastic design

- Compact
- Vertical position for optimum bleeding and functionality
- Bleeding port on top extremity
- Single cylinder design (same for right and left)

Multi-dome Technology



ERGOPOWER EPS DB

Complete customization

Both brake and upshifting levers are completely customizable to the rider's needs and preferences by using a simple allen key

Mode Button



ERGOPOWER EPS DB

AMS

Not only ergonomics but also performance. AMS setting allows for fine-tuning of brake performance and free stroke to meet each individual cyclist's personal preference

FRONT DERAILLEUR

SUPER RECORD™ EPS

SUPER RECORD™ EPS

FRONT DERAILLEUR

Campagnolo motors

Extreme strength and precision



Thin cage and specific setting for crossings

A prompt reply of the front derailleur is guaranteed when shifting

Extremely fluid front shifting even under heavy load



Inner semi-cage design optimized for excellent chainring engagement

Maximum shifting fluidity thanks to the cage shape which helps the chain engage the chainring

Automatic Chain Centering

Communication from rear derailleur allows front derailleur to adjust position



Flawless, 12 speed specific, front shifting

Advanced and meticulously studied form and new intelligence from interface

REAR DERAILLEUR

SUPER RECORD™ EPS

SUPER RECORD™ EPS

REAR DERAILLEUR

Trajectory curve optimized for 11-29 and 11-32 cassettes

Improved shifting performance having the upper pulley always working very close to each sprocket



Upper body in aluminum:

fantastic resistance to impact

Thinner internal cage width

- Larger gap between rd cage and spokes in rotation
- More reliable design
- Increased safety of rider and product
- Easier adjustment of rear derailleur



Multi-Shift Technology

Precise and lightning fast shifting performance up to 11 sprockets at a time

Traditional mech hanger specific rear derailleur geometry



No compromise construction

Lightning fast
Extremely strong
Extremely resistant

Improved ergonomics



Upgraded brake lever

result of meticulous hand movement studies (double curve brake lever, new form outward curve)

Customizeable ergonomics



Larger thumb shifting lever

New hood design
Vari Cushion technology



Upshifting lever enlarged

ERGOPOWER™

*SUPER RECORD™
RECORD™
CHORUS™*

Upshifting lever incorporated into brake lever



*SUPER RECORD™
RECORD™
CHORUS™*

ERGOPOWER™

Ultra Shift™ mechanism maintained

up to 5 sprockets in downshifting - Unique to Campagnolo
up to 3 gears in upshifting



Breaking lever pivot aligned with slant of Ergopower™

better, more efficient power transfer requiring less energy from riders hand



One lever One action



Completely redesigned internals

perfect compatibility with completely new rear derailleur



FRONT DERAILLEUR

SUPER RECORD
RECORD
CHORUS

Completely new design
builds upon successes
of Rev11+



Separation of semi-rod
from external rod:

Eliminates free stroke
Quicker, more immediate, reactive
front upshifting

New Design and Trajectory Angle



Dual position of
cable grip bolt

Allows for use of tires up to 32mm

Allows for cable position to be
adapted to specific needs:
customizeable for differing tire
sizes and frame designs



SUPER RECORD
RECORD
CHORUS

FRONT DERAILLEUR

Thin cage and specific
setting for crossings

A prompt reply of the front derailleur
is guaranteed when shifting



Inner semi-cage design
optimized for excellent
chainring engagement

Maximum values of shifting fluidity
thanks to the cage which helps the
chain in engaging the chainring



Dedicated positions
for each chainring and
each scenario for each
chainring



REAR DERAILLEUR

SUPER RECORD™
RECORD™
CHORUS™

Upper body in
ULTRA-LIGHT
technopolymer reinforced
with UD Carbon Fiber

Extremely low weight, with same
Campagnolo resistance and rigidity



REAR DERAILLEUR

SUPER RECORD™
RECORD™
CHORUS™

One Rear Derailleur
fits all

Unique medium size cage, 72,5mm

Trajectory curve optimized
for 11-29, 11-32 and 11-34
cassettes

Improved shifting performance
having the upper pulley always
working very close to each sprocket



One Rear Derailleur
fits all

Allows uniform performance
between 11-29, 11-32 and 11-34
cassette

3D-Embrace technology

Embrace evolved --> from 2D to 3D
The inner mechanism allows rear
derailleur to embrace more teeth per
sprockets thanks to the advanced position
of the upper pulley (2D). This allows
to have really high values of torque
resistance even on the 11 sprocket and
to have the same chain length even
changing cassette or chainrings

Unique position of the upper wheel pulley
The upper wheel moves to the same
position (compared to the sprocket)
independently from the chainring
engaged. This is obtained with a
gearwheel system which works better
that the competitor's spring system

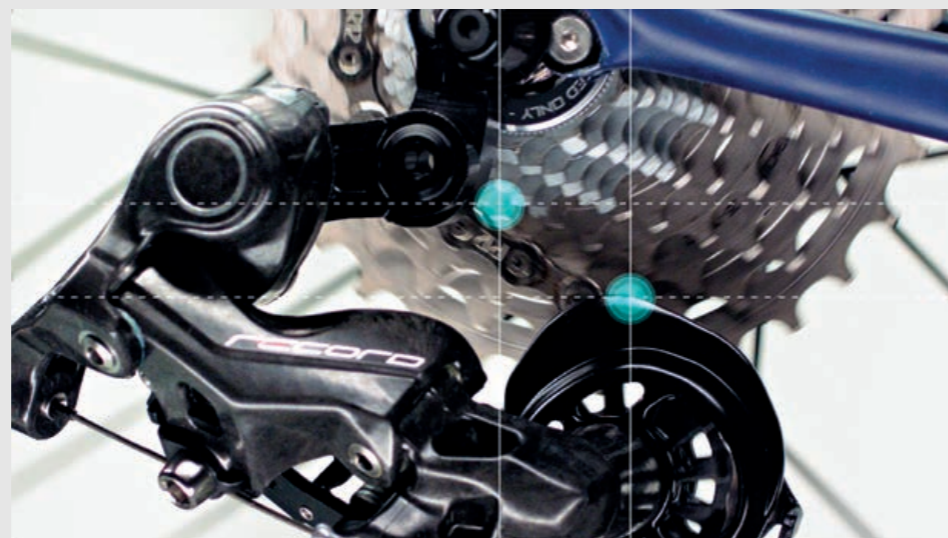

Larger Pulley Wheels

Larger, 12 tooth design

Longer, pronounced tooth design
upper wheel

Rounded lower profile tooth design
on lower wheel to improve fluidity in
chain crossing scenarios

Allows for greater versatility in
cassette compatibility and eliminates
need to alter chain length

REAR DERAILLEUR

*SUPER RECORD™
RECORD™
CHORUS™*

Thinner internal cage width

Larger gap between rear derailleur cage and spokes in rotation

More reliable design

Increased safety of rider and product

Easier adjustment of rear derailleur



REAR DERAILLEUR

*SUPER RECORD™
RECORD™
CHORUS™*

Travel limit screws on back of upper body

Upper body adjustment



Upper body return spring

Absorbs road vibration and protects integrity of rear derailleur

Versatile Hanger System

Standard or Direct hanger assembly allows perfect compatibility of rear derailleur with any frame: disc or rim, direct mount or classic hanger

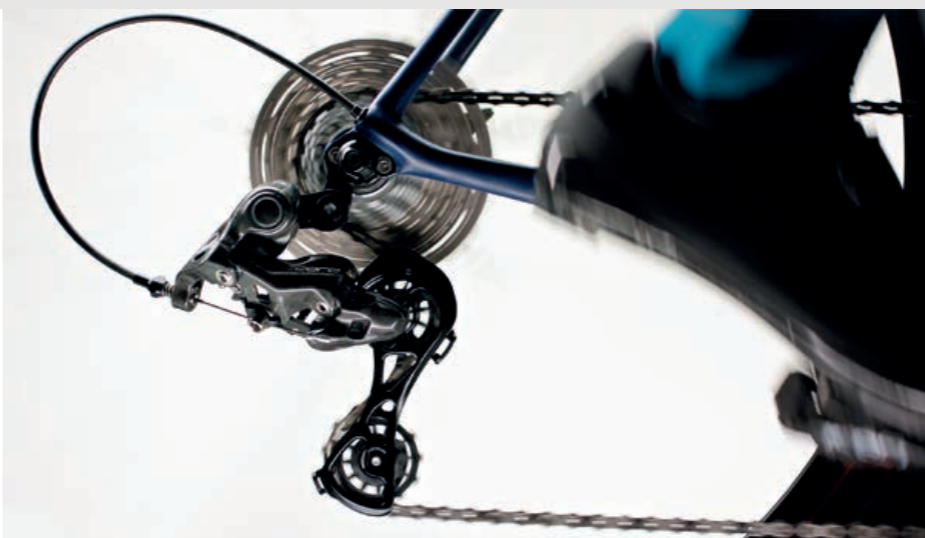

It does all of that at only 3 g more than the previous version (Super Record). Technically an increase... if we were comparing to 11s...

Total weight 181 g

CHAIN

SUPER RECORD
CHORUS

Incorporating an additional gear into the same space

presented the Campy Tech lab with a challenge as an additional gear added without widening rear spacing meant that both cogs and chain would need to be slimmer

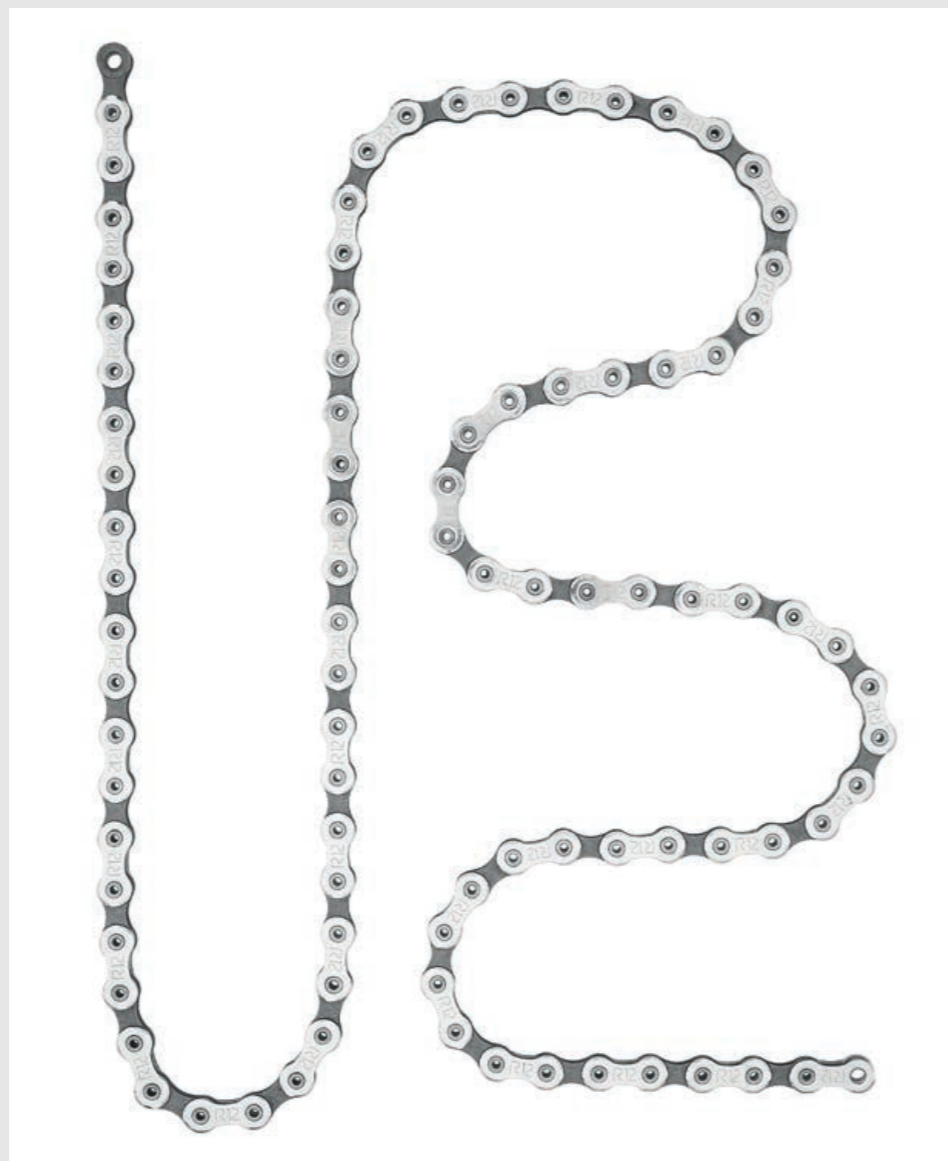

The new 12-speed chain, while thinner and lighter, engages quicker and maintains the exact same durability of its 11-speed predecessor



SUPER RECORD
CHORUS

CASSETTES

With 12 gears, the need for a wide range of cassettes is effectively eliminated as the extra gear allows for single tooth increments all the way to the 7th sprocket!



3 cassettes available:
11-29, 11-32 and 11-34:

11-12-13-14-15-16-17-19-21-23-26-29

11-12-13-14-15-16-17-19-22-25-28-32

11-12-13-14-15-16-17-19-22-25-29-34

Same cassette width: total compatibility with the current free-hub bodies and the current frames rear chainstays width, obtained with thinner sprockets

The new cassettes are completely compatible with current freehub bodies and rear spacing remains unchanged, allowing the rider to continue with his or her same wheels and frame without a problem

CASSETTES

SUPER RECORD
CHORUS

Extra gear in cassette without increasing width = reducing space between cogs as well as width of individual cogs



SUPER RECORD
CHORUS

CASSETTES

Machined aluminum spacers

guaranteed optimum spacing to ensure perfect alignment and shifting for the life of the transmission



Lay-out with the last 2 triplets in monolithic steel

Maximum stiffness in the biggest sprockets

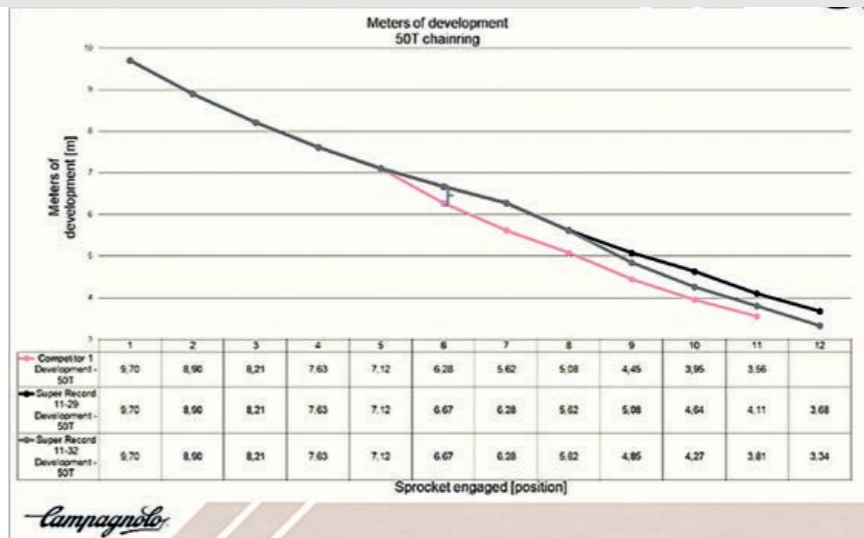

An extra gear makes for more efficient gearing with less gaps

Technical treatment on the sprocket surface

Increasing the sprocket life via chemical intervention

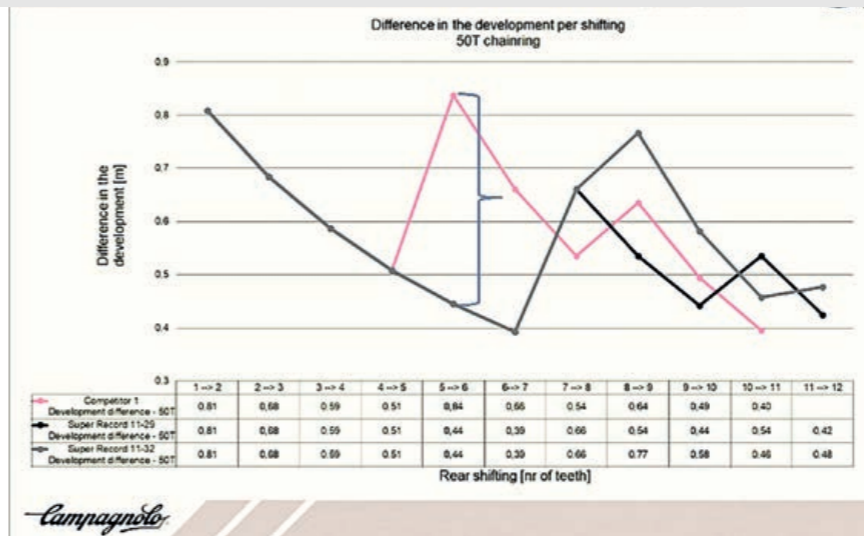
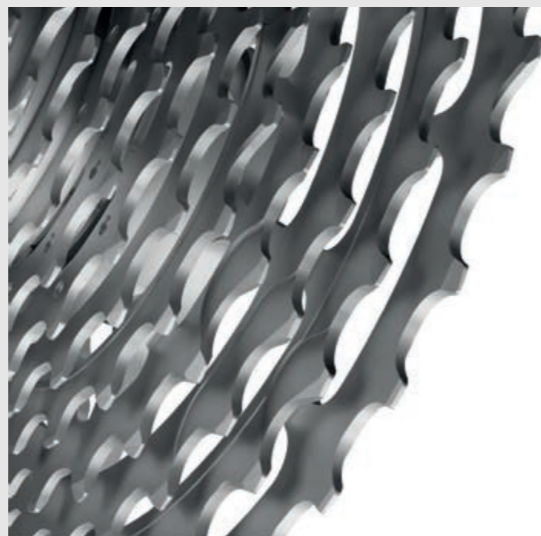

Metric development remains linear

CRANKSET *SUPER RECORD™*

Smoother, more aerodynamic design



SUPER RECORD™ **CRANKSET**

Ultra torque titanium axle

Closure on left crank



Advanced Campagnolo Carbon Technology

New and advanced carbon layup

Unidirectional carbon finish

Hollow carbon construction

Aggressive weight with no compromises in terms of stiffness, reactivity or reliability



CULT™ ceramic bearings



Q factor unvaried:
145.5 mm



Improved 4 arm spider design:

Optimized bolt circle diameter:
8 bolt design locates bolts in perfect position for each independent chainring

Increased stiffness, rigidity and as a consequence reactivity

Optimized component integrity and reliability

112 mm + 145 mm



CRANKSET

SUPER RECORD™

Structural rigidity improved via added support material on larger chainring

Reinforced "brace" adds structural integrity to component where highest torque applied



SUPER RECORD™

CRANKSET

Internally developed hard anodization process

Increases integrity and longevity of component



One crankset fits all:

50/34
52/36
53/39



Symmetrical turning on the inner chainring teeth

Increased versatility and lower friction in situations of extreme chain crossing

**Available in 4 lengths:
165, 170, 172.5, 175**



Chainring combination specific shifting designs

Differing number and location of pins and shifting zones according to chainring combination

Tooth design specific to chainring combination

Ensures optimum location of shift zones during pedal stroke

Considers differing diameter between standards

BRAKES

SUPER RECORD
RECORD

Traditional rim New aerodynamic design

Smooth contours



New aerodynamic design

Overall form more coherent with aero frames



Compatibility with tires up to 28mm in width

Perfect for both C7 and C19 inner width rims



SUPER RECORD
RECORD

BRAKES

Lever Movement on bearings

Increased smoothness

Aids in modularity



Traditional rim Brake shoe with exclusive attach / release system for brake pads



Direct Mount

increased rigidity thanks to Campagnolo direct mount brace solution

ease of build thanks to same brace

integrity of both brake and frame maintained thanks to brace (alternative solutions push frames open)



ERGOPOWER™ DB

*SUPER RECORD™
RECORD™
CHORUS™*

Building on the backs of the fantastic H11 Ergopower commands, which ushered in a new level of personalized ergonomics and control, the new Super Record and Record commands incorporate new advancements to ensure they earn their top-level standing.



ERGOPOWER™ DB

*SUPER RECORD™
RECORD™
CHORUS™*

Campagnolo, never being content on leaving good enough alone, strives to make great better and in doing so has improved upon ergonomics even further by incorporating a new form to the brake lever. Internal studies showed that this new form optimized access to the brake lever for all hand forms and sizes from the drops and made for a safer hand position when engaging the lever.

As with H11 the new Ergopowers are only 8mm taller than their rim brake counterparts, offering an additional hand position without altering ergonomics or ruining the finely crafted aesthetics of the component.



New forms for the upshifting levers

Larger and easier to find
Externally oriented for easy reach

Master cylinder: this low profile is made possible thanks to a fantastic design for the master cylinder

COMPACT
Vertical position for optimum bleeding and functionality

Bleeding port on top extremity

Single cylinder design (same for right and left)

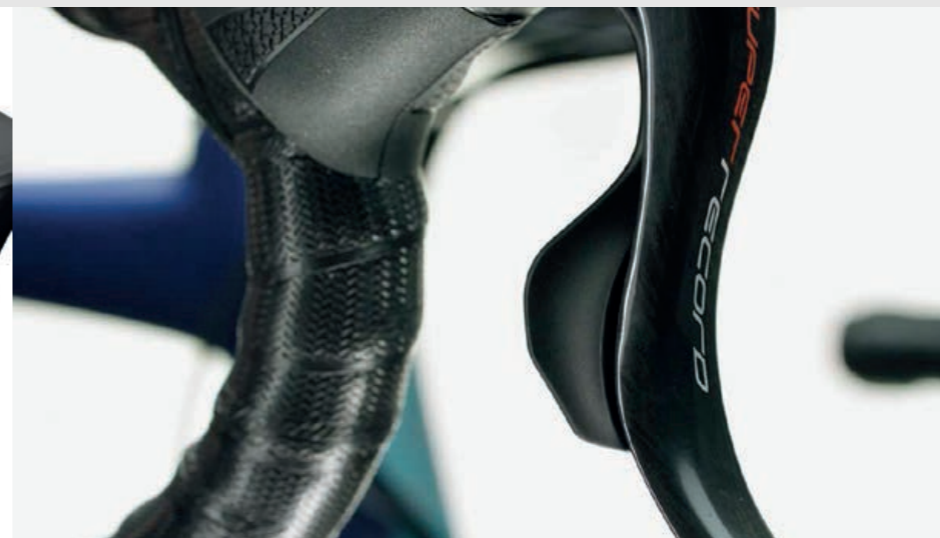

New forms for the upshifting levers

Profiled to match perfectly with the contours of the brake lever

ERGOPOWER™ DB

*SUPER RECORD™
RECORD™
CHORUS™*

New forms for the downshifting lever

Easier location of commands during even the most demanding and extreme efforts.

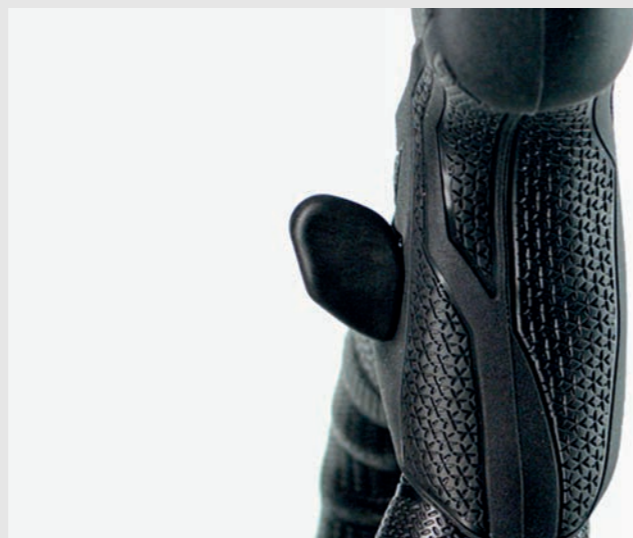

One lever action is maintained

AMS –Adjustable Modulation System (for Super Record and Record):

Complete customization
Just as with the H11 predecessor this customization applies not only to the ergonomics but also to the performance as the AMS setting allows for fine-tuning of the brakes performance and free stroke to meet each individual cyclists personal preference.



Brake lever adjustment dial allows for precise customization of lever's initial position



New internals:

Specifically designed for new componentry

Indexing and throw specific to 12 speed

Improved leverage and reduced force design

ERGOPOWER™ DB

*SUPER RECORD™
RECORD™
CHORUS™*

*SUPER RECORD™
RECORD™
CHORUS™*

ERGOPOWER™ DB

Ultra Shift™ optimized for 12 Speed:

with one single movement, multiple downshift of up to 5 sprockets at a time (unique to Campagnolo) and upshifts of up to three allow for immediate and decisive changes in gearing when the course or the situation demands.



CABLES

New, super-low-friction cables and housing, make for easier upshifting that requires not only less force

Freestroke elimination in upshifting

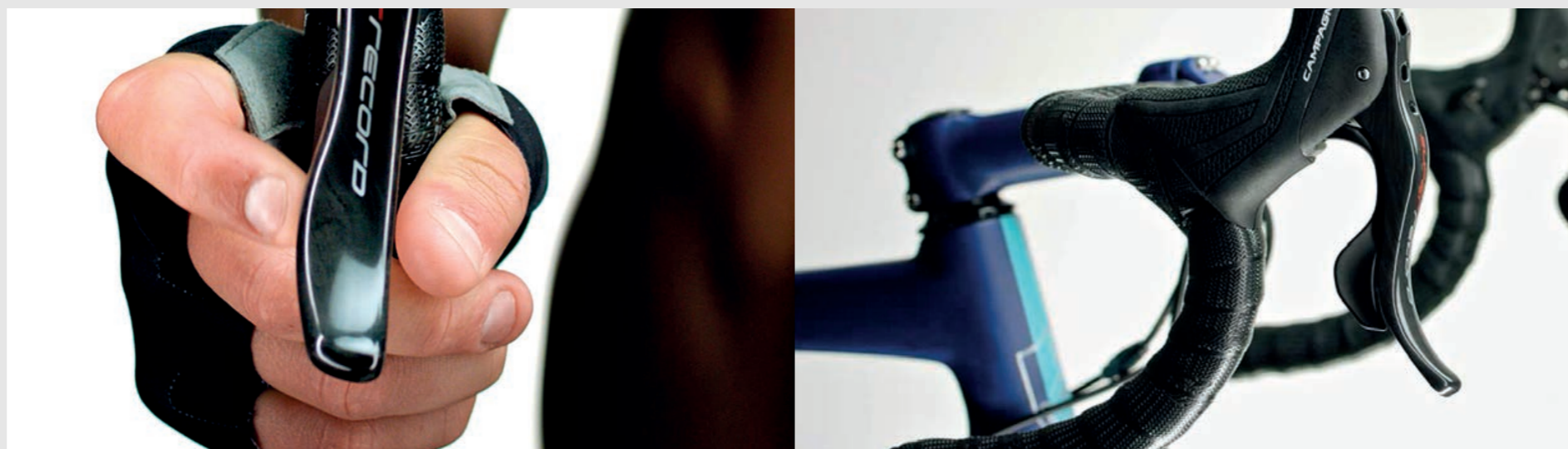

Combined with new Ergopower™ internals + new fd and rd, smoothest shifting with minimal hand movement required

The starting point of the upshift now begins more towards the outside and as such eliminates useless free-stroke, a characteristic unique to Campagnolo.



Not only extremely smooth but very durable performance

CALIPERS

Forged aluminum for optimum system integrity and rigidity



No need for adaptors

Front caliper for 160 mm disc

Rear caliper for 160 or 140 mm disc

perfectly compatible with all flat mount frames



Calipers mount by use of only two screws



CALIPERS

Two screw system:

eliminates additional componentry - fewer pieces = less weight

Two screw system:

simpler construction increases integrity and performance all bolts visible for inspection, reducing risk and increasing safety

PISTONS: LIGHTWEIGHT AND POWERFUL 22 mm

phenolic resin construction

material specifically chosen for thermal insulation qualities

material specifically chosen for thermal insulation qualities

provide great power transfer from command to pad

CALIPERS

Piston-calliper connector:

the return action of the pistons is now optimised, rapidly returning the pads to their position and thus ensuring an overall clearance between pad and disc of 0.4-0.8 mm, with no risk of accidental contact



Brake Pads

Organic resin pad compound:

extremely resistant to heat

provides uniform and consistent braking performance despite varied temperature or climatic conditions



Frame:

high performance pad requires highly resistant frame

special steel structure ensures system integrity under duress



CALIPERS

Visible wear indicator:

included in pad construction

Special shape:
serves to simplify wheel change process by guiding disc into place



Roll Back:

ensures smooth and efficient pedaling



0,4mm distance guaranteed by Campagnolo is even with industry leader



DISC

AFS Axial Fixing System

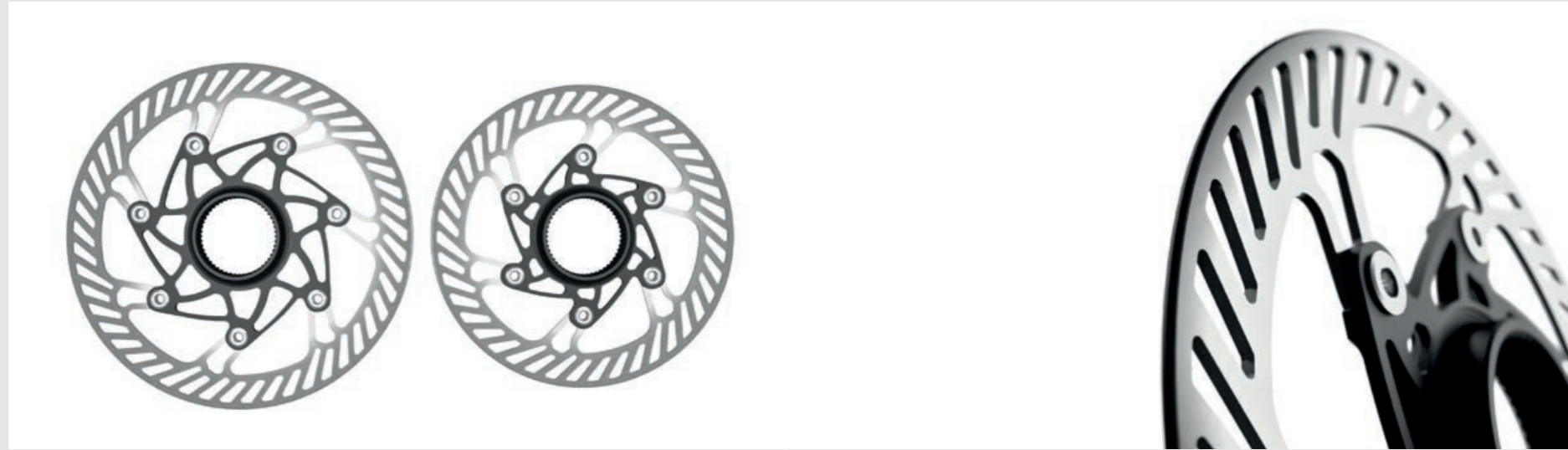

Rounded edge to ensure maximum safety



Fundamental key to extreme performance and safety

extreme resistance to heat

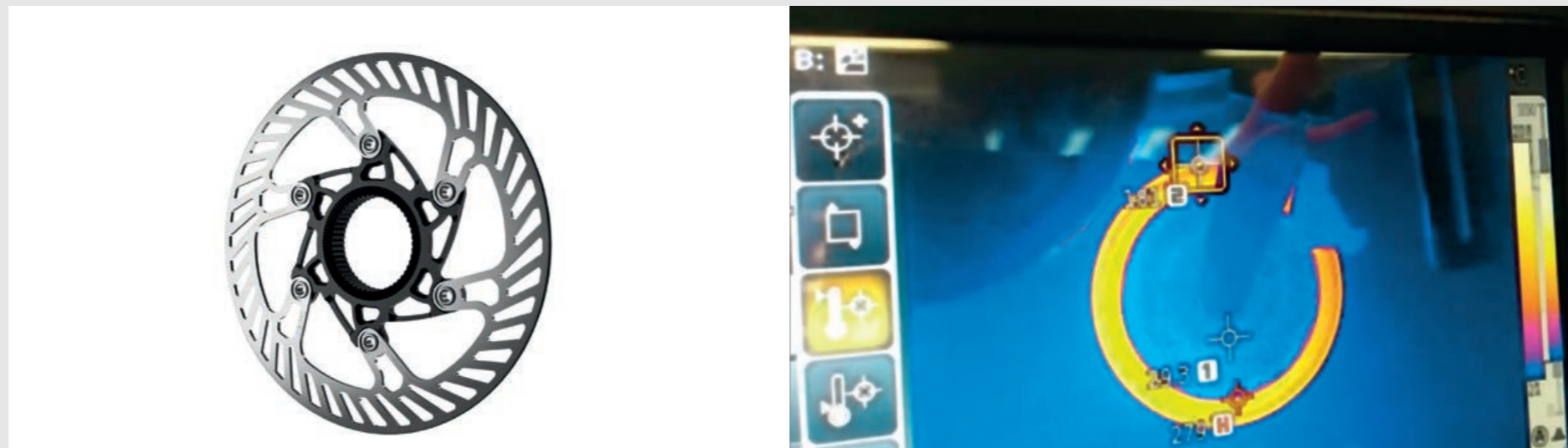

DISC

Campagnolo disc brake rotors:

dissipate heat in safe and uniform manner while guaranteeing performance in situations of heat that compromise the functionality and safety of competing products

Total Unit Extreme Heat Resistance:

performance and safety guaranteed

Resistance to heat Tests



MYCAMPY™ APP

MyCampy™ : your cycling world in the palm of your hand!

Campagnolo®, throughout its prestigious 80+ year history, has introduced numerous game changing technologies that have seen the greatest champions the world has known to victory. From the invention of the first quick release came the first 8, 9, 10, 11 and 12 speed transmissions, the first complete wheelset, the first tenso-structure wheel and a cornucopia of other products universally lauded for their quality and extreme performance characteristics. With so many fantastic products and unique performance solutions the one thing missing was not a physical component but rather a system that helps the cyclist manage his cycling componentry and certain aspects of his or her cycling in a complete and efficient manner. The new MyCampy™ App seeks to do just that ...and all in the palm of your hand...and all for free!

MyCampy™ App is your do-it-all companion that assists you in managing your cycling activity and cycling kit both in the saddle and off. From keeping track of your entire garage of bikes and the components built on each one to EPS™ performance analytics and complete customization of its performance, the new application is as much your own “neutral support” as well as your personal “Sporting Director” and much more. It allows you to interact in a 360° manner with your cycling “stable” and gain a more complete Campagnolo experience all from the comfort of your smartphone, pc or tablet.



Download MyCampy™ today and experience Campagnolo® like never before.

Some of its principal functions include:

MyGarage™:

keep a detailed look over all of your cycling equipment, know exactly how many kilometers each and every component, wheel, chain or cassette has done and when it might be time to perform general maintenance to keep things functioning like new.

MyEPS™:

offers the possibility of interacting in a 360° manner with your Campagnolo® electronic drivetrain by connecting wirelessly with your EPS™ groupset in order to: fully customize commands and system performance, instantly download and install new firmware, offer real-time diagnostics for each and every individual EPS™ component.

MySessions™:

a sophisticated analytical tool that offers a unique look into your performance in addition to how it is affected by your use of components. Track each and every shift, know exactly where when and how you were riding a specific segment in addition to getting tips and suggestions to improve your efficiency on the bike all in conjunction with the innovative wifi capabilities of the V3 EPS™ interface.

Campagnolo® World:

stay up to date with all of the latest happenings in the world of Campagnolo... race results, new product launches, events etc all in one app.

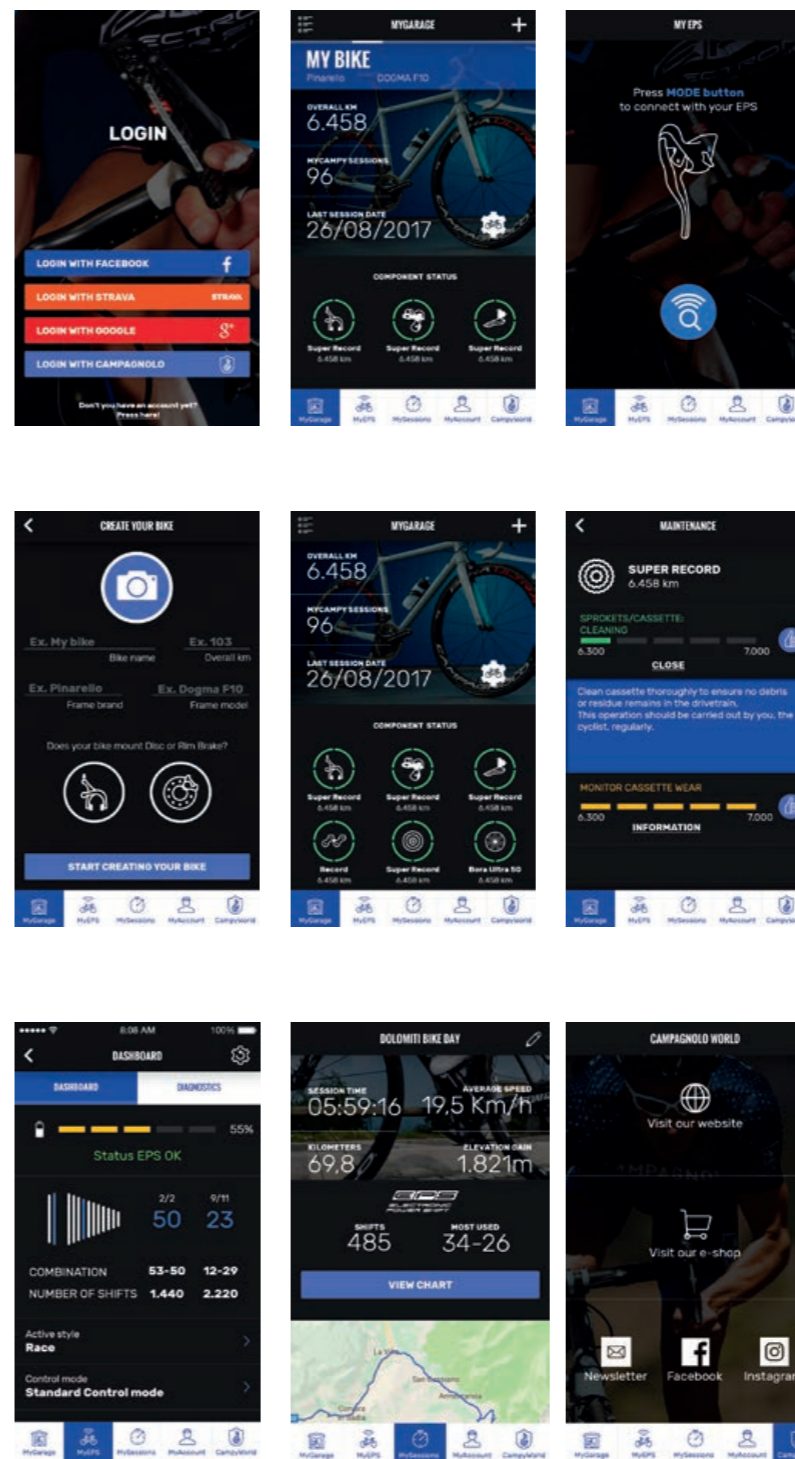



With the popular disc brake system and introduction of the 12-speed, Campagnolo **Super Record™ EPS™** now ticks all the boxes on the market for maintaining its historic role as a benchmark in terms of performance and quality for more demanding cyclists.

Fast shifting, always precise and effortless for the cyclist, and a very gradual gear ratio are just some of the extraordinary characteristics of the new EPS™ groupset, whose performance is ensured by the tried and tested Campagnolo disc brake system and the AMS and Reach adjustment management options.

12x2 SUPER RECORD™ EPS™ REAR DERAILLEUR 234 g **12x2 DTI™ EPS™ V4 INTERFACE** 11 g

HIGH TORQUE, HIGH DRIVE RATIO MOTORS - SPECIAL T.I.N.™ TREATMENT - FRONT PLATE AND CAGE IN CARBON FIBRE - MULTI-SHIFTING™ TECHNOLOGY - POSITION SENSOR - LOWER BODY IN MONOLITHIC CARBON POWDER TECHNOLYMER - UPPER BODY IN ALUMINIUM - EXCLUSIVE "UNLOCK SYSTEM™" - 100% WATERPROOF

DIALOGUE WITH "MYCAMPY" APP: wireless system to communicate with "MyCampy" App by PC / Notebook / Tablet / Smartphone (BTLE), which allows the EPS groupset holder to personalize its own settings - EASY ACCESS TO THE CHARGING PORT - "ZERO SETTING" AND "RIDE SETTING" - LED RGB - TWO VERSIONS AVAILABLE: EXTERNAL (33 g) INTERNAL (on handlebar or frame)

12x2 SUPER RECORD™ EPS™ FRONT DERAILLEUR 132 g **12x2 SUPER RECORD™ CHAIN** 220 g

SPECIAL CAGE DESIGN - FRONT DERAILLEUR BODY IN MONOLITHIC CARBON TECHNOLYMER - POSITION SENSOR - HIGH TORQUE, HIGH DRIVE RATIO MOTORS - 100% WATERPROOF - CSD™ (CHAIN SECURITY DEVICE)

ULTRA-LINK™ CHAIN LINK CONNECTING SYSTEM - ULTRA-LINK™ CHAIN LINKS: designed to provide maximum performance to Campagnolo® transmissions: longer life for chainrings and sprockets, maximum efficiency in power transmission.

12x2 DTI™ EPS™ V4 POWER UNIT 135 g **12x2 SUPER RECORD™ CASSETTE** 266 g

SEATPOST MOUNT COMPATIBLE - SPECIALLY DEVELOPED INTERNAL CASING DESIGNED TO MAKE SYSTEM 100% WATERPROOF - DTI™ DIGITAL TECH INTELLIGENCE - SEAT TUBE/ DOWN TUBE ADAPTOR MOUNT - +10% AUTONOMY COMPARED TO THE V3

ULTRA-SHIFT™ TEETH DESIGN - ULTRA-SHIFT™ SYNCHRONIZATION - LAST TWO TRIPLETS MACHINED FROM MONOLITHIC STEEL FOR STIFFER STRUCTURE, LOWER WEIGHT AND PRECISE SHIFTING - CHAIN RETENTION TEETH ON 12TH SPROCKET

12x2 SUPER RECORD™ CRANKSET 618 g **CAMPAGNOLO® CALIPER** 118 g

FULL COMPATIBILITY WITH DISC AND RIM BRAKE FRAMES - Q FACTOR MAINTAINED AT 145,5 mm - NEW CHAINRINGS - ULTRA-TORQUE™ AXLE - TITANIUM AXLE AND REVERSE THREAD TITANIUM FIXING BOLT - OPTIMIZED UPSHIFTING PINS FOR EACH CHAINRING COMBINATION - HOLLOW CRANKS AND SPIDER ARMS WITH ULTRA-HOLLOW™ TECHNOLOGY - CULT™ TECHNOLOGY - 8 BOLT RETENTION DESIGN INCREASES EFFICIENCY - CAMPAGNOLO® ULTRA-TORQUE™ BB CUPS REQUIRED - REINFORCEMENT BRACE FOR INCREASED STIFFNESS IN AREAS OF HIGHEST TORQUE APPLICATION

FLAT MOUNT STANDARD - AVAILABLE CALIPERS: 160 mm FRONT (123 g PADS INCLUDED), 140 mm AND 160 mm (115 g / 119 g PADS INCLUDED) - ADAPTER FOR USE ON 140 mm FRONT - 22mm PISTON WIDTH IN EVERY CALIPER - RAPID RETURN OF THE PADS TO THEIR POSITION - 0,4 - 0,8 mm ROLL-BACK (RETURN) - PADS WITH WEAR LIMIT INDICATOR - ROUNDED EDGES ON THE PAD - ANTI VIBRATION METAL SHEET - CLEANER BIKE DESIGN - FAST AND SAFE ASSEMBLY - RETURN SPRING BETWEEN THE PADS - UNIQUE BLEND WITH ORGANIC DRY/WET RESIN

12x2 SUPER RECORD™ EPS™ DB ERGOPOWER™ 381 g **CAMPAGNOLO® 03 ROTOR** 99 g

CARBON FIBRE BRAKE LEVER WITH UNIDIRECTIONAL FINISH - NEW ERGONOMICS OF THE ERGOPOWER™ BODY - NEW BRAKE LEVER ERGONOMICS - BRAKE LEVER WITH DOUBLE CURVE - AMS™ ADJUSTMENT (ADJUSTABLE MODULATION SYSTEM) - REACH ADJUSTMENT - HYDRAULIC MASTER CYLINDER - BLEEDING PORT ON THE TOP OF THE ERGOPOWER™ - VARI CUSHION™ HOOD - VERY LOW RESISTANCE OF UPSHIFTING AND DOWNSHIFTING LEVERS - MULTI-DOME TECH ON THE DOWNSHIFTING LEVER

COMPATIBLE WITH CL / AFS HUBS - ROUNDED EXTERNAL EDGE - TWO DIMENSIONS AVAILABLE: 140 mm (99 g) AND 160 mm (120 g) - HIGH HEAT RESISTANCE - DIFFERENT QUANTITY OF SPOKES PER EACH DIMENSION - RIVET CONNECTION ENGINEERED TO ATTAIN SAFE DISTANCE BETWEEN ROTOR AND CALIPER, PROMOTING EFFICIENT COOLING UNDER STRESS - SEMI-FLOATING TECHNOLOGY



Super Record™ EPS™ Rim Brake, the feather in the cap of Campagnolo® innovation thanks to the technologies, materials and expertise behind the design of this groupset, consolidates its benchmark role by moving up to a 12-speed. This very popular groupset, winner of the Giro d'Italia, the Vuelta, the World Championships and many

other races on the World Tour circuit, is now available in a 12-speed option with its V4 version in Power Unit electronic components and interface. The groupset has been redesigned to adapt perfectly to the new 12-speed technological frontier and to the 11-29 and 11-32 cassette combinations introduced in the mechanical version.

- 12x2

SUPER RECORD™ EPS™ REAR DERAILLEUR 234 g

HIGH TORQUE, HIGH DRIVE RATIO MOTORS - SPECIAL T.I.N.™ TREATMENT - FRONT PLATE AND CAGE IN CARBON FIBRE - MULTI-SHIFTING™ TECHNOLOGY - POSITION SENSOR - LOWER BODY IN MONOLITHIC CARBON POWDER TECHNOLYMER - UPPER BODY IN ALUMINIUM - EXCLUSIVE "UNLOCK SYSTEM™" - 100% WATERPROOF

12x2
- 12x2

DTI™ EPS™ V4 INTERFACE 11 g

DIALOGUE WITH "MYCAMPY" APP: wireless system to communicate with "MyCampy" App by PC / Notebook / Tablet / Smartphone (BTLE), which allows the EPS groupset holder to personalize its own settings - EASY ACCESS TO THE CHARGING PORT - "ZERO SETTING" AND "RIDE SETTING" - LED RGB - TWO VERSIONS AVAILABLE: EXTERNAL (33 g) INTERNAL (on handlebar or frame)

12x2
- 12x2

SUPER RECORD™ EPS™ FRONT DERAILLEUR 132 g

SPECIAL CAGE DESIGN - FRONT DERAILLEUR BODY IN MONOLITHIC CARBON TECHNOLYMER - POSITION SENSOR - HIGH TORQUE, HIGH DRIVE RATIO MOTORS - 100% WATERPROOF - CSD™ (CHAIN SECURITY DEVICE)

12x2
- 12x2

SUPER RECORD™ CHAIN 220 g

ULTRA-LINK™ CHAIN LINK CONNECTING SYSTEM - ULTRA-LINK™ CHAIN LINKS: designed to provide maximum performance to Campagnolo® transmissions: longer life for chainrings and sprockets, maximum efficiency in power transmission.

12x2
- 12x2

DTI™ EPS™ V4 POWER UNIT 135 g

SEATPOST MOUNT COMPATIBLE - SPECIALLY DEVELOPED INTERNAL CASING DESIGNED TO MAKE SYSTEM 100% WATERPROOF - DTI™ DIGITAL TECH INTELLIGENCE - SEAT TUBE/ DOWN TUBE ADAPTOR MOUNT - +10% AUTONOMY COMPARED TO THE V3

12x2
- 12x2

SUPER RECORD™ CASSETTE 266 g

ULTRA-SHIFT™ TEETH DESIGN - ULTRA-SHIFT™ SYNCHRONIZATION - LAST TWO TRIPLETS MACHINED FROM MONOLITHIC STEEL FOR STIFFER STRUCTURE, LOWER WEIGHT AND PRECISE SHIFTING - CHAIN RETENTION TEETH ON 12TH SPROCKET

12x2

- 12x2

SUPER RECORD™ CRANKSET 618 g

FULL COMPATIBILITY WITH DISC AND RIM BRAKE FRAMES - Q FACTOR MAINTAINED AT 145,5 mm - NEW CHAINRINGS - ULTRA-TORQUE™ AXLE - TITANIUM AXLE AND REVERSE THREAD TITANIUM FIXING BOLT - OPTIMIZED UPSHIFTING PINS FOR EACH CHAINRING COMBINATION - HOLLOW CRANKS AND SPIDER ARMS WITH ULTRA-HOLLOW™ TECHNOLOGY - CULT™ TECHNOLOGY - 8 BOLT RETENTION DESIGN INCREASES EFFICIENCY - CAMPAGNOLO® ULTRA-TORQUE™ BB CUPS REQUIRED - REINFORCEMENT BRACE FOR INCREASED STIFFNESS IN AREAS OF HIGHEST TORQUE APPLICATION

12x2
- 12x2

SUPER RECORD™ EPS™ ERGOPOWER™ CONTROLS 280 g

CARBON FIBRE BRAKE LEVER WITH UNIDIRECTIONAL FINISH
ONE LEVER-ONE ACTION: each lever of the command set has its own distinct function. This means absolute certainty of using the right control in all conditions (winter temperatures and gloves, poor road conditions etc.), eliminating the risk of error.
100% WATER-PROOF: all control components are built to operate in any weather conditions in compliance with the IP67 standard.
MODE BUTTON: the "Mode" buttons allow the user to check battery charge, make fine adjustments to the rear or front derailleur - even in the middle of a race (with the "ride setting" procedure), and set the zero position of the rear and front derailleur ("zero setting" procedure).
E-ERGONOMY™: the new lower position of the lever 3 ensures easier access from all riding positions allowing the athlete to shift easily from the hoods or the drops.
MULTI-DOME TECH™: the 5-dome technology perfected by Campy Tech Lab™ together with Campagnolo® athletes has made it possible to strike the perfect balance between operating force and tactile shift feedback. It also eliminates the possibility of unintentionally shifting the rear or front derailleur.

12x2
- 12x2

SUPER RECORD™ BRAKES 311 g

MOVEMENT OF LEVERS ON BEARING - SPECIAL COMPOUND - EXCLUSIVE BRAKE PAD COUPLING/UNCOUPLING SYSTEM - DUAL PIVOT BRAKES - NEW FRONT LEVER DESIGN FOR MAXIMUM AERODYNAMIC PENETRATION

12x2
- 12x2

CAMPAGNOLO® DIRECT MOUNT BRAKE 168 g*

CAMPAGNOLO® BRAKE SHOE STANDARD - FAST ASSEMBLY - FAST ADJUSTMENTS - MAXIMUM COMPATIBILITY - NEW FRONT LEVER DESIGN FOR MAXIMUM AERODYNAMIC PENETRATION - RIGID REAR STRUCTURAL BRACE FOR POWERFUL, SAFE BRAKING - * Weight of one brake

12x2



reddot award 2019
winner



The new **Super Record™ 12x2 Speed Disc Brake** groupset is Campagnolo's highest expression of technology and evolution. It is geared towards riders who want to equip their bicycle with the best the market offers in terms of performance and distinctiveness. The new groupset is presented on the market with an innovative rear derailleur

designed with 3D Embrace technology that enables the chain to maintain the highest level of traction, even on the smallest sprockets. The Disc Brake technology developed by Campagnolo ensures that the Super Record groupset has the greatest braking force and modularity possible.

12x2
SUPER RECORD™ FRONT DERAILLEUR 79 g
SPECIAL INNER CAGE DESIGN - OUTER SEMI-CAGE IN MONOCOQUE CARBON - CSD (CHAIN SECURITY DEVICE) - DERAILLEUR CLAMP - DUAL POSITION CABLE CLOSURE ALLOWS FOR VERSATILE CABLE POSITION AND BETTER TIRE CLEARANCE- SPLIT CONNECTING ROD FOR SMOOTH DERAILING

12x2
SUPER RECORD™ CRANKSET 618 g
FULL COMPATIBILITY WITH DISC AND RIM BRAKE FRAMES - Q FACTOR MAINTAINED AT 145,5 mm - NEW CHAINRINGS - ULTRA-TORQUE™ AXLE - TITANIUM AXLE AND REVERSE THREAD TITANIUM FIXING BOLT - OPTIMIZED UPSHIFTING PINS FOR EACH CHAINRING COMBINATION - HOLLOW CRANKS AND SPIDER ARMS WITH ULTRA-HOLLOW™ TECHNOLOGY - CULT™ TECHNOLOGY - 8 BOLT RETENTION DESIGN INCREASES EFFICIENCY - CAMPAGNOLO® ULTRA-TORQUE™ BB CUPS REQUIRED - REINFORCEMENT BRACE FOR INCREASED STIFFNESS IN AREAS OF HIGHEST TORQUE APPLICATION

CAMPAGNOLO® CALIPER 118 g
FLAT MOUNT STANDARD - AVAILABLE CALIPERS: 160 mm FRONT (123 g PADS INCLUDED), 140 mm AND 160 mm (115 g / 119 g PADS INCLUDED) - ADAPTER FOR USE ON 140 mm FRONT - 22mm PISTON WIDTH IN EVERY CALIPER - RAPID RETURN OF THE PADS TO THEIR POSITION - 0,4 - 0,8 mm ROLL-BACK (RETURN) - PADS WITH WEAR LIMIT INDICATOR - ROUNDED EDGES ON THE PAD - ANTI VIBRATION METAL SHEET - CLEANER BIKE DESIGN - FAST AND SAFE ASSEMBLY - RETURN SPRING BETWEEN THE PADS - UNIQUE BLEND WITH ORGANIC DRY/WET RESIN

CAMPAGNOLO® ROTOR 03 99 g
COMPATIBLE WITH CL / AFS HUBS - ROUNDED EXTERNAL EDGE - TWO DIMENSIONS AVAILABLE: 140 mm (99 g) AND 160 mm (120 g) - HIGH HEAT RESISTANCE - DIFFERENT QUANTITY OF SPOKES PER EACH DIMENSION - RIVET CONNECTION ENGINEERED TO ATTAIN SAFE DISTANCE BETWEEN ROTOR AND CALIPER, PROMOTING EFFICIENT COOLING UNDER STRESS - SEMI-FLOATING TECHNOLOGY

12x2
SUPER RECORD™ REAR DERAILLEUR 181 g
UPPER PULLEY WHEELS WITH LONGER TEETH - LOWER PULLEY WHEELS WITH ROUNDED TEETH - 3D EMBRACE TECHNOLOGY™ - CARBON FIBER CAGE CONSTRUCTION - PARALLELOGRAM WITH TECHNOLOGY POLYMER EXTERNAL CONNECTING ROD WITH UD FINISH (UNIDIRECTIONAL) - TITANIUM REAR DERAILLEUR FIXING SCREW - 12-TOOTH PULLEY WHEELS - JOINT FOR MOUNTING ON STANDARD OR DIRECT MOUNT DROP-OUTS - COMPATIBLE WITH SPROCKET SETS 11-29, 11-32, 11-34

12x2
SUPER RECORD™ CHAIN 220 g
ULTRA-LINK™ CHAIN LINK CONNECTING SYSTEM - ULTRA-LINK™ CHAIN LINKS: designed to provide maximum performance to Campagnolo® transmissions: longer life for chainrings and sprockets, maximum efficiency in power transmission.

12x2
SUPER RECORD™ DB ERGOPOWER™ CONTROLS 462 g
CARBON FIBRE BRAKE LEVER WITH UNIDIRECTIONAL FINISH - NEW ERGONOMICS OF THE ERGOPOWER™ BODY - NEW BRAKE LEVER ERGONOMICS - BRAKE LEVER WITH DOUBLE CURVE - AMS™ ADJUSTMENT (ADJUSTABLE MODULATION SYSTEM) - REACH ADJUSTMENT - HYDRAULIC MASTER CYLINDER - BLEEDING PORT ON THE TOP OF THE ERGOPOWER™ - ONE LEVER ONE ACTION - VARI-CUSHION™ BRAKE LEVER HOODS WITH VARIABLE DENSITY AND SURFACE FINISHES - ULTRA-SHIFT™ FUNCTION ALLOWS FOR MULTIPLE SHIFTING AND GREATER CONTROL FOR RACING - DERAILLEUR CABLE ADJUSTING BARREL

12x2
SUPER RECORD™ CASSETTE 266 g
ULTRA-SHIFT™ TEETH DESIGN - ULTRA-SHIFT™ SYNCHRONIZATION - LAST TWO TRIPLETS MACHINED FROM MONOLITHIC STEEL FOR STIFFER STRUCTURE, LOWER WEIGHT AND PRECISE SHIFTING - CHAIN RETENTION TEETH ON 12TH SPROCKET - SPROCKET SETS AVAILABLE: 11-29, 11-32, 11-34 (NEW)



The **Super Record™ 12x2 Speed Rim Brake** groupset is the highest expression of the prestigious Italian brand's technology and evolution. It is meant for those who want to fit their bicycle with the best the market has in terms of performance and distinction. The drive to improve what is already considered a reference point results in every

single detail being tended to, including the most minute. The Super Record groupset is both extremely lightweight and very sturdy. This groupset is the crowned jewel of Campagnolo® innovation and the technologies, material and expertise that the groupset is made with place it in a category apart.

12x2 SUPER RECORD™ FRONT DERAILLEUR 79 g
 SPECIAL INNER CAGE DESIGN - OUTER SEMI-CAGE IN MONOCOQUE CARBON - CSD (CHAIN SECURITY DEVICE) - DERAILLEUR CLAMP - DUAL POSITION CABLE CLOSURE ALLOWS FOR VERSATILE CABLE POSITION AND BETTER TIRE CLEARANCE- SPLIT CONNECTING ROD FOR SMOOTH DERAILING

12x2 SUPER RECORD™ CRANKSET 618 g
 FULL COMPATIBILITY WITH DISC AND RIM BRAKE FRAMES - Q FACTOR MAINTAINED AT 145,5 mm - NEW CHAINRINGS - ULTRA-TORQUE™ AXLE - TITANIUM AXLE AND REVERSE THREAD TITANIUM FIXING BOLT - OPTIMIZED UPSHIFTING PINS FOR EACH CHAINRING COMBINATION - HOLLOW CRANKS AND SPIDER ARMS WITH ULTRA-HOLLOW™ TECHNOLOGY - CULT™ TECHNOLOGY - 8 BOLT RETENTION DESIGN INCREASES EFFICIENCY - CAMPAGNOLO® ULTRA-TORQUE™ BB CUPS REQUIRED - REINFORCEMENT BRACE FOR INCREASED STIFFNESS IN AREAS OF HIGHEST TORQUE APPLICATION

12x2 SUPER RECORD™ REAR DERAILLEUR 181 g
 UPPER PULLEY WHEELS WITH LONGER TEETH - LOWER PULLEY WHEELS WITH ROUNDED TEETH - 3D EMBRACE TECHNOLOGY™ - CARBON FIBER CAGE CONSTRUCTION - PARALLELOGRAM WITH TECHNO-POLYMER EXTERNAL CONNECTING ROD WITH UD FINISH (UNIDIRECTIONAL) - TITANIUM REAR DERAILLEUR FIXING SCREW - 12-TOOTH PULLEY WHEELS - JOINT FOR MOUNTING ON STANDARD OR DIRECT MOUNT DROP-OUTS - COMPATIBLE WITH SPROCKET SETS 11-29, 11-32, 11-34

12x2 SUPER RECORD™ CHAIN 220 g
 ULTRA-LINK™ CHAIN LINK CONNECTING SYSTEM - ULTRA-LINK™ CHAIN LINKS: designed to provide maximum performance to Campagnolo® transmissions: longer life for chainrings and sprockets, maximum efficiency in power transmission.

12x2 SUPER RECORD™ CASSETTE 266 g
 ULTRA-SHIFT™ TEETH DESIGN - ULTRA-SHIFT™ SYNCHRONIZATION - LAST TWO TRIPLETS MACHINED FROM MONOLITHIC STEEL FOR STIFFER STRUCTURE, LOWER WEIGHT AND PRECISE SHIFTING - CHAIN RETENTION TEETH ON 12TH SPROCKET - SPROCKET SETS AVAILABLE: 11-29, 11-32, 11-34 (NEW)

SUPER RECORD™ BRAKES 311 g
 MOVEMENT OF LEVERS ON BEARING - SPECIAL COMPOUND - EXCLUSIVE BRAKE PAD COUPLING/UNCOUPLING SYSTEM - DUAL PIVOT BRAKES - NEW FRONT LEVER DESIGN FOR MAXIMUM AERODYNAMIC PENETRATION

CAMPAGNOLO® DIRECT MOUNT BRAKE 168 g*
 CAMPAGNOLO® BRAKE SHOE STANDARD - FAST ASSEMBLY - FAST ADJUSTMENTS - MAXIMUM COMPATIBILITY - NEW FRONT LEVER DESIGN FOR MAXIMUM AERODYNAMIC PENETRATION - RIGID REAR STRUCTURAL BRACE FOR POWERFUL, SAFE BRAKING - * Weight of one brake

12x2 SUPER RECORD™ ERGOPOWER™ CONTROLS 339 g
 CARBON FIBRE BRAKE LEVER WITH UNIDIRECTIONAL FINISH - ULTRA-SHIFT™ ERGONOMICS: safe grip on handlebars in all positions and faster, more precise command on levers. VARI-CUSHION™ BRAKE LEVER HOODS WITH VARIABLE DENSITY AND SURFACE FINISHES: natural silicone material with differentiated areas to follow the grip of the 1st and 2nd finger. The special design drains off water keeping the support cover dry and increasing grip. Internal weave to create a variable thickness that guarantees maximum comfort. ULTRA-SHIFT™ FUNCTION ALLOWS FOR MULTIPLE SHIFTING AND GREATER CONTROL FOR RACING: Campagnolo® offers the only mechanical groupset available with the capability of shifting multiple gears (up to 5 sprockets). Multishifting allows the rider to react immediately to rapid changes in the course or necessary gearing. DERAILLEUR CABLE ADJUSTING BARREL: enables the tension of the derailleur cable to be adjusted perfectly, slashing adjustment time. DOUBLE CURVATURE BRAKE LEVER: allows you to engage and modulate the brake safely from any hand position. CUSTOM ERGONOMICS THANKS TO ADJUSTABLE BRAKE LEVER POSITION



Campagnolo's evolution is relentless, and the world of mechanical transmissions is about to change with the arrival of a new and sophisticated innovation: the 12-speed Record Disc Brake groupset. The twelfth sprocket heralds a new era for mechanical groupsets, allowing cyclists to achieve levels of versatility that have never been reached before,

matched with Campagnolo's typical quality and reliability. The design of the new Record™ 12x2 Speed groupset originated from a blank canvas, redesigning all components to improve their performance, while maintaining the same overall dimensions to retain full compatibility with the frames and wheels on the market.

RECORD™ FRONT DERAILLEUR 81 g
 SPECIAL INNER CAGE DESIGN - ALUMINUM OUTER SEMI-CAGE - CSD (CHAIN SECURITY DEVICE) - DERAILLEUR CLAMP - DUAL POSITION CABLE CLOSURE ALLOWS FOR VERSATILE CABLE POSITION AND BETTER TIRE CLEARANCE- SPLIT CONNECTING ROD FOR SMOOTH DERAILING

RECORD™ CRANKSET 708 g
 FULL COMPATIBILITY WITH DISC AND RIM BRAKE FRAMES - Q FACTOR MAINTAINED AT 145,5 mm - ULTRA-TORQUE™ AXLE - NEW CHAINRINGS - OPTIMIZED UPSHIFTING PINS FOR EACH CHAINRING COMBINATION - 8 BOLT RETENTION DESIGN INCREASES EFFICIENCY - CAMPAGNOLO® ULTRA-TORQUE™ BB CUPS REQUIRED

CAMPAGNOLO® CALIPER 118 g
 FLAT MOUNT STANDARD - AVAILABLE CALIPERS: 160 mm FRONT (123 g PADS INCLUDED), 140 mm AND 160 mm (115 g / 119 g PADS INCLUDED) - ADAPTER FOR USE ON 140 mm FRONT - 22mm PISTON WIDTH IN EVERY CALIPER - RAPID RETURN OF THE PADS TO THEIR POSITION - 0,4 - 0,8 mm ROLL-BACK (RETURN) - PADS WITH WEAR LIMIT INDICATOR - ROUNDED EDGES ON THE PAD - ANTI VIBRATION METAL SHEET - CLEANER BIKE DESIGN - FAST AND SAFE ASSEMBLY - RETURN SPRING BETWEEN THE PADS - UNIQUE BLEND WITH ORGANIC DRY/WET RESIN

CAMPAGNOLO® 03 ROTOR 99 g
 COMPATIBLE WITH CL / AFS HUBS - ROUNDED EXTERNAL EDGE - TWO DIMENSIONS AVAILABLE: 140 mm (99 g) AND 160 mm (120 g) - HIGH HEAT RESISTANCE - DIFFERENT QUANTITY OF SPOKES PER EACH DIMENSION - RIVET CONNECTION ENGINEERED TO ATTAIN SAFE DISTANCE BETWEEN ROTOR AND CALIPER, PROMOTING EFFICIENT COOLING UNDER STRESS - SEMI-FLOATING TECHNOLOGY

RECORD™ REAR DERAILLEUR 216 g
 UPPER PULLEY WHEELS WITH LONGER TEETH - LOWER PULLEY WHEELS WITH ROUNDED TEETH - 3D EMBRACE TECHNOLOGY™ - LOWER BODY IN MONOLITHIC TECHNOPOLYMER WITH CARBON ELEMENTS - ALUMINUM FRONT PLATE - PARALLELOGRAM WITH TECHNOPOLYMER EXTERNAL CONNECTING ROD - JOINT FOR MOUNTING ON STANDARD OR DIRECT MOUNT DROP-OUTS - COMPATIBLE WITH SPROCKET SETS 11-29, 11-32, 11-34

SUPER RECORD™ CHAIN 220 g
 ULTRA-LINK™ CHAIN LINK CONNECTING SYSTEM - ULTRA-LINK™ CHAIN LINKS: designed to provide maximum performance to Campagnolo® transmissions: longer life for chainrings and sprockets, maximum efficiency in power transmission.

RECORD™ DB ERGOPOWER™ CONTROLS 463 g
 CARBON FIBRE BRAKE LEVER WITH UNIDIRECTIONAL FINISH - NEW ERGONOMICS OF THE ERGOPOWER™ BODY - NEW BRAKE LEVER ERGONOMICS - BRAKE LEVER WITH DOUBLE CURVE - AMS™ ADJUSTMENT (ADJUSTABLE MODULATION SYSTEM) - REACH ADJUSTMENT - HYDRAULIC MASTER CYLINDER - BLEEDING PORT ON THE TOP OF THE ERGOPOWER™ - ONE LEVER ONE ACTION - VARI-CUSHION™ BRAKE LEVER HOODS WITH VARIABLE DENSITY AND SURFACE FINISHES - ULTRA-SHIFT™ FUNCTION ALLOWS FOR MULTIPLE SHIFTING AND GREATER CONTROL FOR RACING - DERAILLEUR CABLE ADJUSTING BARREL

SUPER RECORD™ CASSETTE 266 g
 ULTRA-SHIFT™ TEETH DESIGN - ULTRA-SHIFT™ SYNCHRONIZATION - LAST TWO TRIPLETS MACHINED FROM MONOLITHIC STEEL FOR STIFFER STRUCTURE, LOWER WEIGHT AND PRECISE SHIFTING - CHAIN RETENTION TEETH ON 12TH SPROCKET - SPROCKET SETS AVAILABLE: 11-29, 11-32, 11-34 (NEW)



With the 12-speed Record™ groupset and Campagnolo® quality, satisfaction and victory are close at hand. With the twelfth sprocket, a new era begins. Enthusiasts will be able to gain unprecedented levels of versatility on their bikes along with the quality and reliability that Campagnolo is known for.

All of this combines with Campagnolo's experience in Dual Pivot and Direct Mount brakes to offer powerful, modurable braking in any situation, including races, without compromising on practical brake assembly or cable tension adjustment.

RECORD™ FRONT DERAILLEUR 81 g
 SPECIAL INNER CAGE DESIGN - ALUMINUM OUTER SEMI-CAGE - CSD (CHAIN SECURITY DEVICE) - DERAILLEUR CLAMP - DUAL POSITION CABLE CLOSURE ALLOWS FOR VERSATILE CABLE POSITION AND BETTER TIRE CLEARANCE- SPLIT CONNECTING ROD FOR SMOOTH DERAILING

RECORD™ CRANKSET 708 g
 FULL COMPATIBILITY WITH DISC AND RIM BRAKE FRAMES - Q FACTOR MAINTAINED AT 145,5 mm - ULTRA-TORQUE™ AXLE - NEW CHAINRINGS - OPTIMIZED UPSHIFTING PINS FOR EACH CHAINRING COMBINATION - 8 BOLT RETENTION DESIGN INCREASES EFFICIENCY - CAMPAGNOLO® ULTRA-TORQUE™ BB CUPS REQUIRED

SUPER RECORD™ CASSETTE 266 g
 ULTRA-SHIFT™ TEETH DESIGN - ULTRA-SHIFT™ SYNCHRONIZATION - LAST TWO TRIPLETS MACHINED FROM MONOLITHIC STEEL FOR STIFFER STRUCTURE, LOWER WEIGHT AND PRECISE SHIFTING - CHAIN RETENTION TEETH ON 12TH SPROCKET - SPROCKET SETS AVAILABLE: 11-29, 11-32, 11-34 (NEW)

RECORD™ ERGOWPOWER™ CONTROLS 343 g
 CARBON FIBRE BRAKE LEVER WITH UNIDIRECTIONAL FINISH - ULTRA-SHIFT™ ERGONOMICS: safe grip on handlebars in all positions and faster, more precise command on levers. VARI-CUSHION™ BRAKE LEVER HOODS WITH VARIABLE DENSITY AND SURFACE FINISHES: natural silicone material with differentiated areas to follow the grip of the 1st and 2nd finger. The special design drains off water keeping the support cover dry and increasing grip. Internal weave to create a variable thickness that guarantees maximum comfort.

RECORD™ REAR DERAILLEUR 216 g
 UPPER PULLEY WHEELS WITH LONGER TEETH - LOWER PULLEY WHEELS WITH ROUNDED TEETH - 3D EMBRACE TECHNOLOGY™ - LOWER BODY IN MONOLITHIC TECHNO-POLYMER WITH CARBON ELEMENTS - ALUMINUM FRONT PLATE - PARALLELOGRAM WITH TECHNO-POLYMER EXTERNAL CONNECTING ROD - JOINT FOR MOUNTING ON STANDARD OR DIRECT MOUNT DROP-OUTS - COMPATIBLE WITH SPROCKET SETS 11-29, 11-32, 11-34

SUPER RECORD™ CHAIN 220 g
 ULTRA-LINK™ CHAIN LINK CONNECTING SYSTEM - ULTRA-LINK™ CHAIN LINKS: designed to provide maximum performance to Campagnolo® transmissions: longer life for chainrings and sprockets, maximum efficiency in power transmission.

RECORD™ BRAKES 326 g*
 SPECIAL COMPOUND - EXCLUSIVE BRAKE PAD COUPLING/UNCOUPLING SYSTEM - DUAL PIVOT BRAKES - NEW FRONT LEVER DESIGN FOR MAXIMUM AERODYNAMIC PENETRATION

CAMPAGNOLO® DIRECT MOUNT BRAKE 168 g*
 CAMPAGNOLO® BRAKE SHOE STANDARD - FAST ASSEMBLY - FAST ADJUSTMENTS - MAXIMUM COMPATIBILITY - NEW FRONT LEVER DESIGN FOR MAXIMUM AERODYNAMIC PENETRATION - RIGID REAR STRUCTURAL BRACE FOR POWERFUL, SAFE BRAKING - * Weight of one brake

ULTRA-SHIFT™ FUNCTION ALLOWS FOR MULTIPLE SHIFTING AND GREATER CONTROL FOR RACING: Campagnolo® offers the only mechanical groupset available with the capability of shifting multiple gears (up to 5 sprockets). Multishifting allows the rider to react immediately to rapid changes in the course or necessary gearing. **DERAILLEUR CABLE ADJUSTING BARREL:** enables the tension of the derailleur cable to be adjusted perfectly, slashing adjustment time. **DOUBLE CURVATURE BRAKE LEVER:** allows you to engage and modulate CUSTOM ERGONOMICS THANKS TO ADJUSTABLE BRAKE LEVER POSITION



The Chorus™ DB 12-speed groupset is available with the specific 48/32 and 11-34 combinations, suitable for those who spend hours and hours on the saddle on mixed terrain, while maintaining the racing performance guaranteed by every Campagnolo groupset.

As per tradition, the use of different materials and consequent little additional weight, together with a rear derailleur redesigned to house larger cassettes are the main elements that make the Chorus™ 12x2 Speed different from the Super Record™ and Record™ groupsets.

CHORUS™ FRONT DERAILLEUR 87 g
 SPECIAL INNER CAGE DESIGN - ALUMINUM OUTER SEMI-CAGE - CSD (CHAIN SECURITY DEVICE) - DERAILLEUR CLAMP - DUAL POSITION CABLE CLOSURE ALLOWS FOR VERSATILE CABLE POSITION AND BETTER TIRE CLEARANCE- SPLIT CONNECTING ROD FOR SMOOTH DERAILING

CHORUS™ CRANKSET 728 g
 FULL COMPATIBILITY WITH DISC AND RIM BRAKE FRAMES - Q FACTOR MAINTAINED AT 145,5 mm - ULTRA-TORQUE™ AXLE - NEW CHAINRINGS - OPTIMIZED UPSHIFTING PINS FOR EACH CHAINRING COMBINATION - 8 BOLT RETENTION DESIGN INCREASES EFFICIENCY - CAMPAGNOLO® ULTRA-TORQUE™ BB CUPS REQUIRED

CAMPAGNOLO® CALIPER 118 g
 FLAT MOUNT STANDARD - AVAILABLE CALIPERS: 160 mm FRONT (123 g PADS INCLUDED), 140 mm AND 160 mm (115 g / 119 g PADS INCLUDED) - ADAPTER FOR USE ON 140 mm FRONT - 22mm PISTON WIDTH IN EVERY CALIPER - RAPID RETURN OF THE PADS TO THEIR POSITION - 0,4 - 0,8 mm ROLL-BACK (RETURN) - PADS WITH WEAR LIMIT INDICATOR - ROUNDED EDGES ON THE PAD - ANTI VIBRATION METAL SHEET - CLEANER BIKE DESIGN - FAST AND SAFE ASSEMBLY - RETURN SPRING BETWEEN THE PADS - UNIQUE BLEND WITH ORGANIC DRY/WET RESIN

CAMPAGNOLO® ROTOR 99 g
 COMPATIBLE WITH CL / AFS HUBS - ROUNDED EXTERNAL EDGE - TWO DIMENSIONS AVAILABLE: 140 mm (99 g) AND 160 mm (120 g) - HIGH HEAT RESISTANCE - DIFFERENT QUANTITY OF SPOKES PER EACH DIMENSION - RIVET CONNECTION ENGINEERED TO ATTAIN SAFE DISTANCE BETWEEN ROTOR AND CALIPER, PROMOTING EFFICIENT COOLING UNDER STRESS - SEMI-FLOATING TECHNOLOGY ON 140 mm DISC

CHORUS™ REAR DERAILLEUR 220 g
 UPPER PULLEY WHEELS WITH LONGER TEETH - LOWER PULLEY WHEELS WITH ROUNDED TEETH - 3D EMBRACE TECHNOLOGY™ - LOWER BODY IN MONOLITHIC TECHNOPOLYMER WITH CARBON ELEMENTS - ALUMINUM FRONT PLATE - PARALLELOGRAM WITH TECHNOPOLYMER EXTERNAL CONNECTING ROD - JOINT FOR MOUNTING ON STANDARD OR DIRECT MOUNT DROP-OUTS

CHORUS™ CHAIN 243 g
 ULTRA-LINK™ CHAIN LINK CONNECTING SYSTEM - ULTRA-LINK™ CHAIN LINKS: designed to provide maximum performance to Campagnolo® transmissions: longer life for chainrings and sprockets, maximum efficiency in power transmission.

CHORUS™ DB ERGOPOWER™ CONTROLS 488 g
 ALUMINIUM BRAKE LEVER - NEW ERGONOMICS OF THE ERGOPOWER™ BODY - NEW BRAKE LEVER ERGONOMICS - BRAKE LEVER WITH DOUBLE CURVE - REACH ADJUSTMENT - HYDRAULIC MASTER CYLINDER - BLEEDING PORT ON THE TOP OF THE ERGOPOWER™ - ONE LEVER ONE ACTION - VARI-CUSHION™ BRAKE LEVER HOODS WITH VARIABLE DENSITY AND SURFACE FINISHES - ULTRA-SHIFT™ FUNCTION ALLOWS FOR MULTIPLE SHIFTING AND GREATER CONTROL FOR RACING - DERAILLEUR CABLE ADJUSTING BARREL

CHORUS™ CASSETTE 310 g
 ULTRA-SHIFT™ TEETH DESIGN - ULTRA-SHIFT™ SYNCHRONIZATION - LAST TWO TRIPLETS MACHINED FROM MONOLITHIC STEEL FOR STIFFER STRUCTURE, LOWER WEIGHT AND PRECISE SHIFTING - CHAIN RETENTION TEETH ON 12TH SPROCKET



Chorus™ 12-speed groupset: the best choice for those wanting typical Campagnolo quality, cutting-edge technologies and reliability, also for endurance cycling.

No compromises have been made in this extension of the characteristics and main advantages of Super Record™ and Record™ 12-speed groupsets to the Chorus™ 12-speed groupset. In addition to this, the Chorus™ model also comes with the brand new Ultra Torque™ 32/48 crankset, together with the new 34/50 and 36/52 chainring combinations.

12x2

CHORUS™ FRONT DERAILLEUR 87 g

SPECIAL INNER CAGE DESIGN - ALUMINUM OUTER SEMI-CAGE - CSD (CHAIN SECURITY DEVICE) - DERAILLEUR CLAMP - DUAL POSITION CABLE CLOSURE ALLOWS FOR VERSATILE CABLE POSITION AND BETTER TIRE CLEARANCE- SPLIT CONNECTING ROD FOR SMOOTH DERAILING

12x2

CHORUS™ CRANKSET 728 g

FULL COMPATIBILITY WITH DISC AND RIM BRAKE FRAMES - Q FACTOR MAINTAINED AT 145,5 mm - ULTRA-TORQUE™ AXLE - NEW CHAINRINGS - OPTIMIZED UPSHIFTING PINS FOR EACH CHAINRING COMBINATION - 8 BOLT RETENTION DESIGN INCREASES EFFICIENCY - CAMPAGNOLO® ULTRA-TORQUE™ BB CUPS REQUIRED

12x2

CHORUS™ ERGPOWER™ CONTROLS 362 g

ALUMINIUM BRAKE LEVER
 ULTRA-SHIFT™ ERGONOMICS: safe grip on handlebars in all positions and faster, more precise command on levers.
 VARI CUSHION™ BRAKE LEVER HOODS WITH VARIABLE DENSITY AND SURFACE FINISHES: natural silicone material with differentiated areas to follow the grip of the 1st and 2nd finger. The grooved areas drain away water, keeping the brake lever hoods dry and improving grip. Internal weave to create a variable thickness that guarantees maximum comfort.
 ULTRA-SHIFT™ FUNCTION ALLOWS FOR MULTIPLE SHIFTING AND GREATER CONTROL FOR RACING: Campagnolo® offers the only mechanical groupset available with the capability of shifting multiple gears (up to 5 sprockets). Multishifting allows the rider to react immediately to rapid changes in the course or necessary gearing.
 DERAILLEUR CABLE ADJUSTING BARREL: enables the tension of the derailleur cable to be adjusted perfectly, slashing adjustment time.
 DERAILLEUR CABLE ADJUSTING BARREL: enables the tension of the derailleur cable to be adjusted perfectly, slashing adjustment time.
 CUSTOM ERGONOMICS THANKS TO ADJUSTABLE BRAKE LEVER POSITION

12x2

CHORUS™ CASSETTE 310 g

ULTRA-SHIFT™ TEETH DESIGN - ULTRA-SHIFT™ SYNCHRONIZATION - LAST TWO TRIPLETS MACHINED FROM MONOLITHIC STEEL FOR STIFFER STRUCTURE, LOWER WEIGHT AND PRECISE SHIFTING - CHAIN RETENTION TEETH ON 12TH SPROCKET

12x2

CHORUS™ REAR DERAILLEUR 220 g

UPPER PULLEY WHEELS WITH LONGER TEETH - LOWER PULLEY WHEELS WITH ROUNDED TEETH - 3D EMBRACE TECHNOLOGY™ - LOWER BODY IN MONOLITHIC TECHNO-POLYMER WITH CARBON ELEMENTS - ALUMINUM FRONT PLATE - PARALLELOGRAM WITH TECHNO-POLYMER EXTERNAL CONNECTING ROD - JOINT FOR MOUNTING ON STANDARD OR DIRECT MOUNT DROP-OUTS

12x2

CHORUS™ CHAIN 241 g

ULTRA-LINK™ CHAIN LINK CONNECTING SYSTEM -
 ULTRA-LINK™ CHAIN LINKS: designed to provide maximum performance to Campagnolo® transmissions: longer life for chainrings and sprockets, maximum efficiency in power transmission.

CHORUS™ BRAKES 318 g*

SKELETON BRAKE ARMS: no-bend arms, modularity, reduced weight -
 SPECIAL COMPOUND - EXCLUSIVE BRAKE PAD COUPLING/UNCOUPLING SYSTEM: fast and secure brake pad replacement - * Dual pivot front/rear

DIRECT™ DIRECT MOUNT BRAKE 183 g*

UNIVERSAL BRAKE SHOE - AERODYNAMIC DESIGN: the solid structure of the front and rear brake shoe levers allows for highly aerodynamic performance -
 FAST ASSEMBLY - FAST ADJUSTMENTS: screws oriented in a direction that allows for the fastest adjustment while guaranteeing easy access to adjustment screws - * one brake weight



The **Centaur™** Rim Brake 11 speed groupset represents Campagnolo® continuous innovation and is a prime example of how top tier technology trickles down to permeate the entire range.

Campagnolo's initial offering comes as an affordable solution while guaranteeing performance generally associated with premium products.

CENTAUR™ REAR DERAILLEUR

230 g

REDESIGNED REAR DERAILLEUR TRAJECTORY ANGLE (45°) - ONE REAR DERAILLEUR AVAILABLE FOR EVERY SETUP COMBINATION - PULLEY WHEELS WITH BUSHINGS - UPPER PULLEY WHEEL WITH LONGER TEETH - LOWER PULLEY WHEEL WITH ROUNDED TEETH - UPPER AND LOWER BODY IN ULTRA-LIGHT TECHNOLOGY REINFORCED WITH GLASS FIBRE - LIMIT SCREWS POSITIONED ON THE BACK OF THE UPPER BODY

CENTAUR™ FRONT DERAILLEUR

103 g

SUPER RECORD™ INFLUENCED DESIGN - ONE-PIECE STEEL CAGE - SHAPED OUTER SEMI-CAG: improve the downshifting speed and chain control during upshifting
NEW ROD DESIGN

CENTAUR™ ERGOPOWER™ CONTROLS

373 g

ALUMINIUM BRAKE LEVER - REDESIGNED RIGHT POWER-SHIFT™ MECHANISM - MULTIPLE UPSHIFTING (UP TO 3 GEARS) - ERGONOMIC DOWNSHIFT LEVER POSITION - NEW LIP INTRODUCED ON THE ERGOPOWER™ BODY - GEOMETRY SPECIFICALLY DESIGNED TO OPTIMIZE COMMAND/HANDLEBAR INTERFACE - HOODS WITH GROOVED ZONES - HOODS IN SILICON WITH VARI-CUSHION™ TECHNOLOGY - LEFT POWER-SHIFT™ MECHANISM COMPATIBLE WITH CENTAUR™ CRANKSET - DOWNWARD MOVEMENT OF THE CHAIN BLOCKED AT 1ST ACTION

CENTAUR™ BRAKES

325 g*

FORGED ALUMINIUM SOLID BRAKE ARMS - ADJUSTABLE BRAKE PADS - SPECIAL BRAKE PAD COMPOUND, REDUCING BRAKING DISTANCE IN BOTH DRY AND WET CONDITIONS. THE MOST APPRECIATED BRAKE PADS ON THE MARKET - * front and rear weight

CENTAUR™ CASSETTE

291 g

SPECIFIC CASSETTES DEVELOPED WITH THE "CAMPAGNOLO 11™" LAYOUT WITH SPECIFIC FINISHING - THREE CASSETTE SPECS AVAILABLE: 11-32, 12-32, 11-29
11-32 CASSETTE WITH THE SPROCKET COMBINATION: 11-12-13-14-15-17-19-22-25-28-32

CAMPAGNOLO 11™ CHAIN

256 g

WIDER LINK DESIGN: the new design of the Campagnolo® 11™ chain increases shifting performance and reduces the noise from chainring and sprocket engagement -
ULTRA-LINK™ CHAIN CONNECTING SYSTEM: high strength chain connection - greater safety and longer chain life

CENTAUR™ CRANKSET

875 g

FOUR ARM DESIGN - TWO CHAINRING COMBINATIONS: 52/36 AND 50/34 - ONE SINGLE CRANK FOR BOTH CHAINRING COMBINATIONS - OPTIMIZED INNER SURFACE ON BOTH CRANKS - ULTRA-TORQUE™ AXLE - CHAINRING INNER DESIGN OPTIMIZED PER EACH COMBINATION - THREE CRANK LENGTHS AVAILABLE: 170, 172,5 AND 175 mm - CAMPAGNOLO® ULTRA-TORQUE™ BB CUPS REQUIRED

DIRECT™ DIRECT MOUNT BRAKE

183 g*

UNIVERSAL BRAKE SHOE - AERODYNAMIC DESIGN: the solid structure of the front and rear brake shoe levers allows for highly aerodynamic performance - FAST ASSEMBLY - FAST ADJUSTMENTS: screws oriented in a direction that allows for the fastest adjustment while guaranteeing easy access to adjustment screws - * one brake weight



WHEELS

WHEEL TECHNOLOGIES

AERO/ PERFORMANCE CARBON WHEELS

BORA™ ULTRA WTO TT	Disc Brake	116
BORA™ ULTRA WTO 80	Disc Brake	119
BORA™ ULTRA WTO 60	Disc Brake	120
BORA™ ULTRA WTO 45	Disc Brake	121
BORA™ ULTRA WTO 33	Disc Brake	122
BORA™ ULTRA TT	Rim Brake	123
BORA™ WTO 77	Rim Brake	124
BORA™ WTO 60	Disc Brake - Rim Brake	125
BORA™ WTO 45	Disc Brake - Rim Brake	126 - 127
BORA™ WTO 33	Disc Brake - Rim Brake	128 - 129
		130 - 131

GRAVEL CARBON WHEELS

LEVANTE™	Disc Brake	132
		134

ENDURANCE CARBON WHEELS

SHAMAL™ CARBON	Disc Brake	136
		138

ALUMINIUM WHEELS

SHAMAL™ ULTRA™	Rim Brake	140
ZONDA™	Disc Brake - Rim Brake	141
SCIROCCO™	Disc Brake - Rim Brake	142 - 143
CALIMA™	Rim Brake	144 - 145
		146



BORA™ WTO Project

Campagnolo® launches the new
Wind Tunnel Optimized Bora™ Wheels

The Campy Tech Lab dedicated its energies towards pushing the limits of aerodynamic efficiency even further. The result of this task force's labor comes in the form of the wheels Bora™ Ultra WTO and Bora™ WTO .

WTO
Wind
Tunnel
Optimized



Such a task saw the engineering team spending as many hours in the wind tunnel as in the office

hence the moniker of WTO

Overall efficiency must be improved by reducing the energy requirement necessary to overcome three important factors:

- aerodynamic resistance
- rolling resistance
- weight/gradients

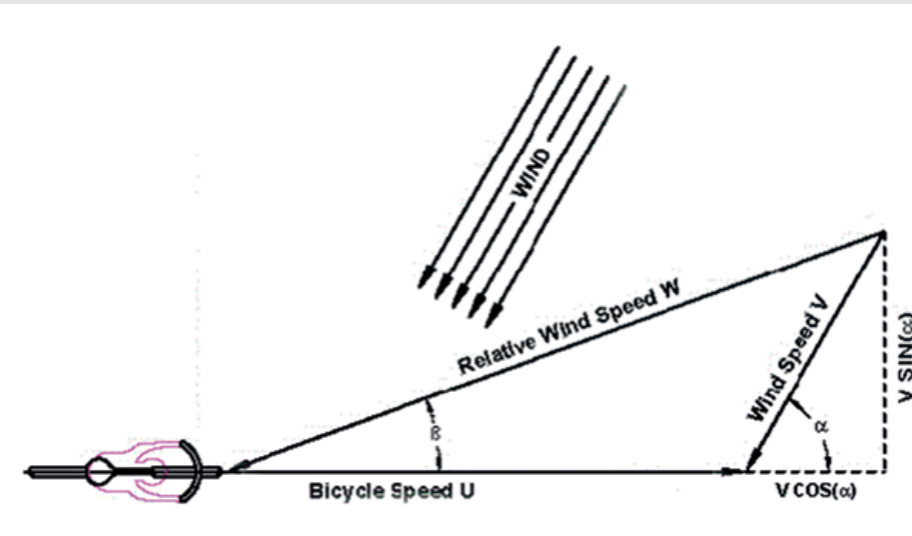

Wind effect is barely ever straightforward:

apparent wind must be accounted for

To Improve the aerodynamic efficiency of the Bora™:

creation of Campagnolo engineering task force wholly dedicated to creating the new aero standard

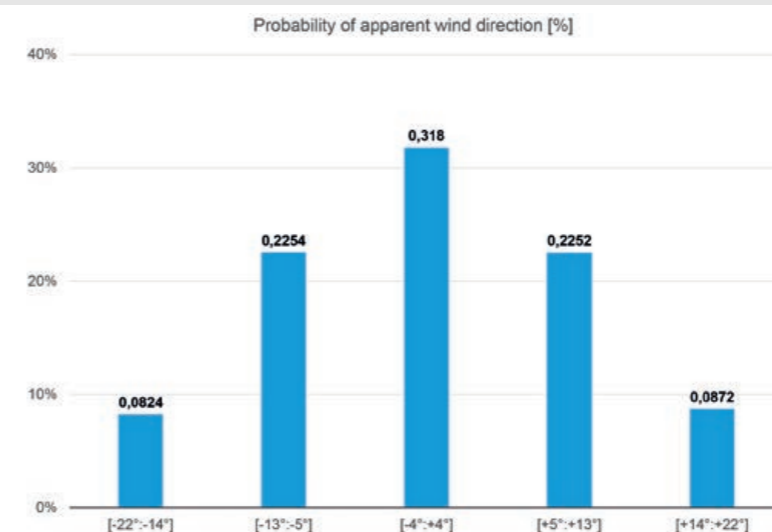

Athletes will encounter a myriad of different wind angles during any given ride:

probability of apparent wind direction [%]

athletes don't race in wind tunnels

nature does not create wind in a uniform manner or from the same direction

Race courses aren't typically straight



WTO
Wind Tunnel Optimized for **REAL WORLD CONDITIONS**

Numerous real world tests performed on two different continents

Riders don't maintain a perfect position

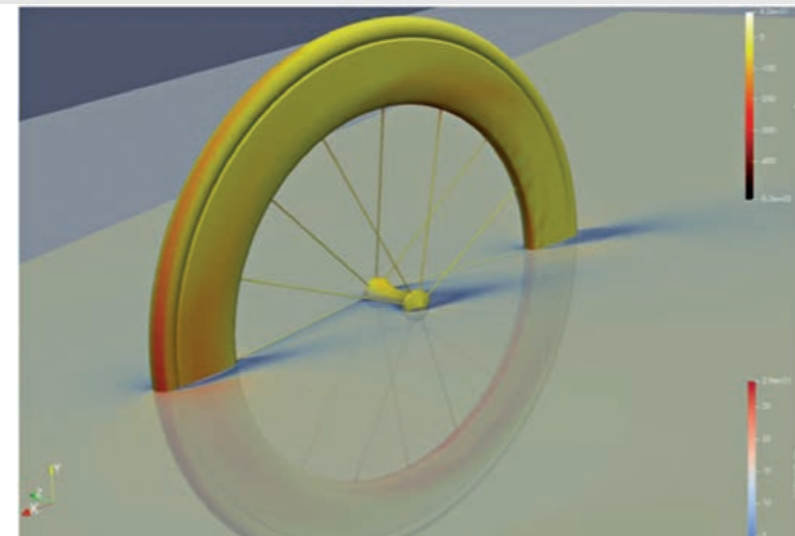

THROUGH:
CFD and FEM analysis

the Campagnolo engineering team produced two aerodynamic profiles that confer the most efficient structure available on the market in terms of drag reduction

Campagnolo engineers set about to account for all of these variables in what has come to represent perhaps the most comprehensive aerodynamic study ever performed by the company to produce wheels

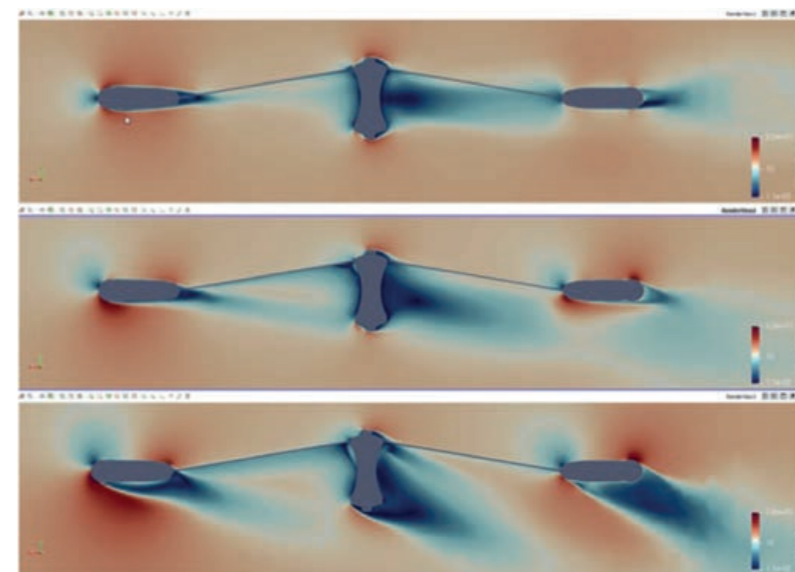

Wind angle: 0°

Wind angle: 10°

Wind angle: 20°

Bora™ WTO 77 45 k/h

The Campagnolo engineering team produced two aerodynamic profiles that confer the most efficient structure available on the market in terms of drag reduction

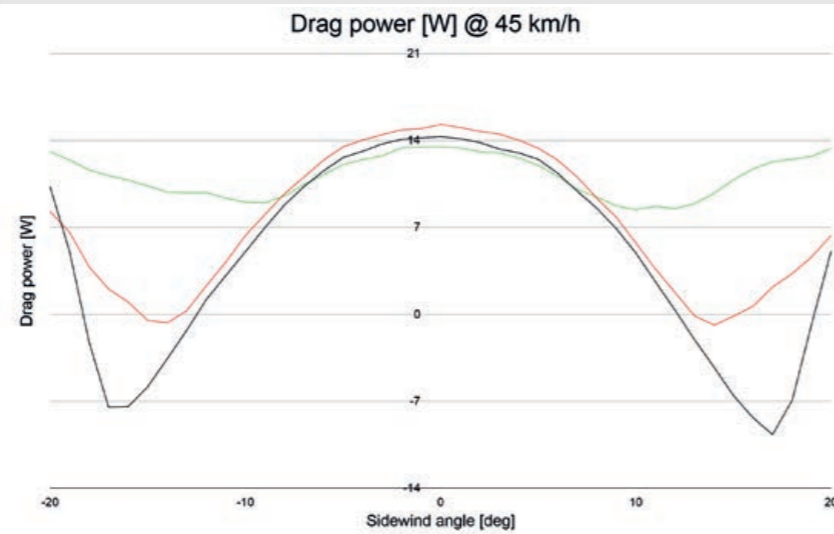

Aerodynamic Hubs:

follows the same design premise of the rim in that it must be aerodynamic in a versatile manner
slimmer towards the center and growing in width towards the flanges

Bora™ WTO 77 55 k/h

The Campagnolo engineering team produced two aerodynamic profiles that confer the most efficient structure available on the market in terms of drag reduction

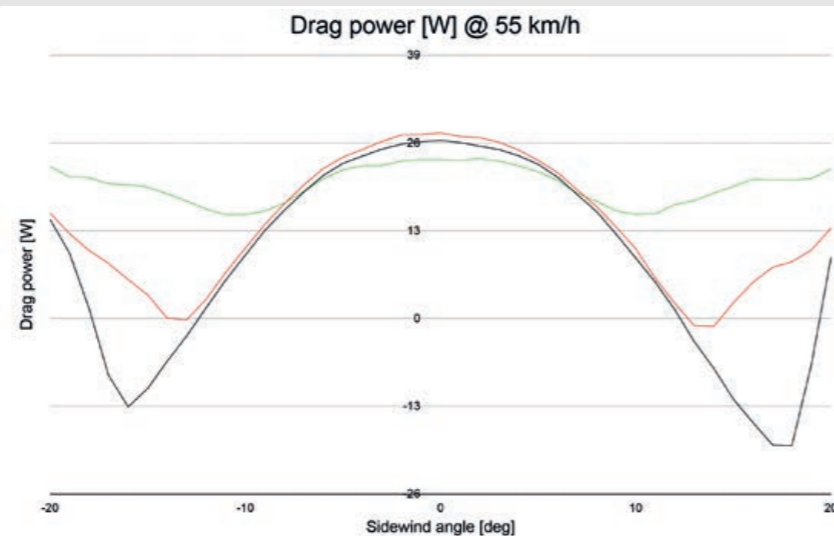

Aerodynamic Spokes:

3D Aero profile
not merely flat but diamond shaped
efficient design that accounts for varied wind conditions

Bora™ Ultra WTO and Bora™ WTO: rim shape:

efficient to the point that it not only reduces drag, but at certain angles is capable of reducing it to the point of negative drag



Reduced number of spokes:

- 16 spokes for Bora WTO 77 mm front wheel
- 18 spokes for 60, 45 and 33 mm Rim Brake front wheel
- 21 spokes for 45 mm Disc Brake front
- 21/G3 spokes for 60, 45 and 33 mm Rim Brake rear wheel
- 24/G3 spokes for 60 and 33 mm Disc Brake

Bora™ Ultra WTO and Bora™ WTO with oversized drive side flange and G3™ spoke pattern

The oversized flange allows for symmetric spoke angles which increase torsional rigidity and result in a more reactive wheel. The G3 spoke pattern incorporates twice as many spokes on the side of highest torque application. Doing so reduces the force applied to each single spoke and increases the rigidity of the overall wheel.



Bora™ WTO 60/45/33 USB™ Ceramic Bearings:

Long lasting
Superior Performance

19mm internal width:

more efficient rim already called for a wider stance in general. The 19mm internal width structure provided the multiple benefit of a better performing rim design: better fit with the tire sizes (23, 25 and 28 mm)

Overall more efficient complete unit (tire + rim) tires take on more aerodynamic shape, rendering both the single component and complete unit more efficient



Bora™ WTO 77 and Bora™ Ultra WTO 60/45/33 CULT™ Ceramic Bearings:

CULT™ bearings have a friction coefficient 40% lower than standard sealed bearings, and in tests, can spin for 5 ½ times longer.

A carbon fiber, 2-Way-Fit™ profile in order to offer the possibility to choose between the two most efficient solutions available is the best solution

Contrary to popular belief, the tubular was the worst performer in terms of rolling resistance



Optimized Construction for Optimum Performance

The lightweight yet extremely reliable performance of the Bora Ultra WTO and Bora WTO wheels comes about thanks to optimizing the employment of extra carbon fiber only in areas where integrity and performance could be improved and likewise eliminating any material that wasn't completely necessary to maintain the Campagnolo quality standard.

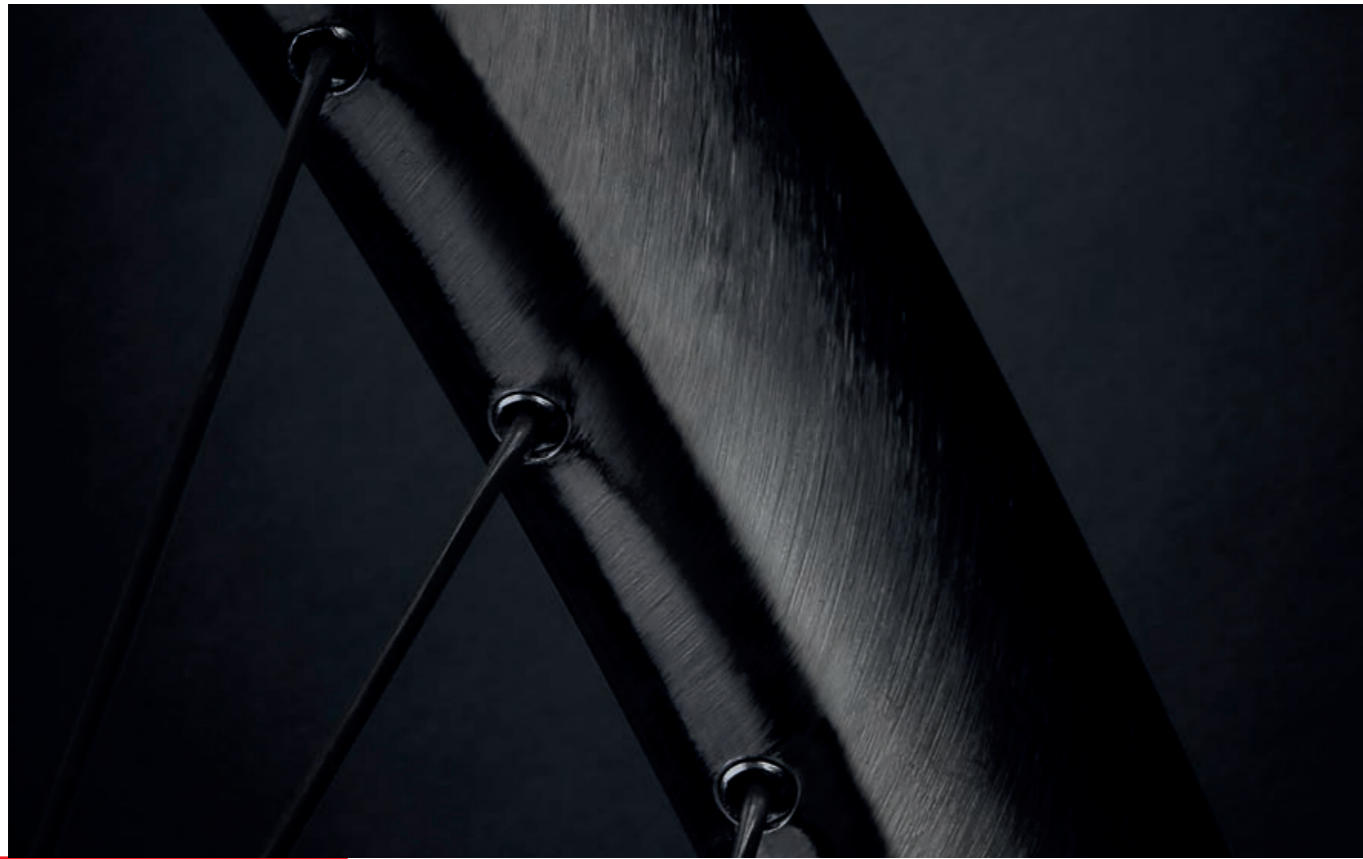

AERO MO-MAG™

The Bora™ Ultra WTO (WTO denoting 'Wind Tunnel Optimised') is designed to offer unparalleled aerodynamic performance in real-world conditions. To achieve this, Campagnolo® has introduced Aero Mo-Mag™ internal nipples. Hidden inside the rim, this latest iteration of Campagnolo's Mo-Mag™ technology allows for cleaner and more efficient airflow when coupled with Campagnolo's aero elliptical spokes.

Aerodynamics isn't the only benefit of the patented technology, as the Mo-Mag™ system allows Campagnolo® to mould the nipple and valve holes into the rims, negating entirely the need to drill holes in the carbon fiber. This increases internal strength, and reduces localised stress, which in turn increases the wheelset's fatigue life. Internalising the nipples in such a way also guarantees perfect alignment, resulting in an even more accurate wheel build.

The benefits don't stop there however, as no drilled holes in the 2-Way Fit™ rim bed means **no need for rim tape, so fitting tubeless, tubeless-ready and clincher tires proves a seamless affair.**

The Aero Mo-Mag™ system even averts the traditional pitfalls of internal nipples by guaranteeing ease-of-adjustment with a supplied tool, meaning **spoke tension can be increased or decreased, even with the tire still in place.**

Equally important is Campagnolo's construction with glass-fiber reinforced polymer plates between the rim and the nipple to improve the leaning and the fatigue life of the system reducing loads and corrosion probability.



H.U.L.C. CONSTRUCTION

The Bora™ Ultra WTO's rims have been completely redesigned across the range with both weight-loss and continued WTO (Wind Tunnel Optimized) performance in mind.

The new rims, aerodynamically optimised for 25mm tires, are constructed from Campagnolo's Hand Made Ultra-Light Carbon. H.U.L.C is the result of extensive development over decades of in-house carbon fiber moulding, enabling Campagnolo's engineers to optimise the usage of both fiber and bonding resin for the perfect blend of strength, stiffness and light weight.

This means the **Bora™ Ultra WTO tips the scales at just 1425g in the 45mm rim format.**

C-LUX FINISH

Fast wheels must look the part too however, so the rim (and front hub) also sports a stunning mirror-like Campagnolo® Luxury (C-LUX) finish.

This C-LUX finish is so pristinely smooth that it doesn't require lacquer, saving weight.

When applied to the rim bed, as Campagnolo® has done for the first time with its new Bora™ Ultra WTO, the scientific precision of C-LUX also helps to ensure the safest possible seating of tubeless tires and further reduces the risk of abrasions to the bead.





N3W™

**N3W™ - NEXT 3 WAYS - IS OUR FUTURE:
A SINGLE STANDARD TO MANAGE
ALL THE CAMPAGNOLO CASSETTES...
PRESENT, PAST AND... STILL TO COME!**

N3W™ is a patented standard for a freewheel body engineered to house 11-, 12- and 13-speed cassettes with 9-, 10- and 11-tooth starting sprockets.

It is also still compatible with older 9- and 10-speed cassettes.

N3W™ has the same groove profile as the classic Campagnolo® body but it is 4.4 mm shorter, making it lighter.

N3W™ is directly compatible with the new Campagnolo® cassettes with 9- and 10-tooth starting sprockets.



Campagnolo® N3W™ freewheel body:

optimized for 12 and 13 speed cassettes starting with sprockets with 10 teeth or less.

The N3W™ body will therefore fitted as standard on our new wheels, all equipped with 36-tooth side rack to give better resistance to the twisting torque



Campagnolo® N3W™ freewheel body + N3W™ adapter:

backward compatibility with 10-11-12 speed cassettes.

The N3W™ standard has been designed with an eye on the future, but Campagnolo® hasn't forgotten its keen cycling fans



**BORA WTO DB,
BORA ONE DB,
ZONDA DB,
SHAMAL ULTRA DB**

Retrofit Kit for current wheels:

if needed, two conversion kits are available
code AC21-N3WRFCC for cone and cup,
cod. AC21-N3WRFCS for sealed bearings,
to adapt your faithful pedaling companions to the new N3W™ standard

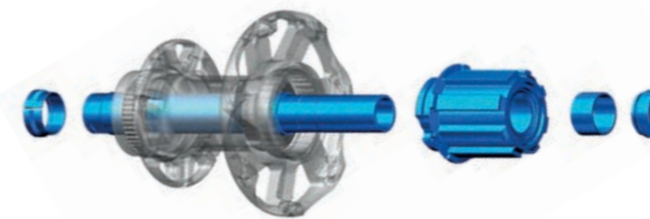

SCIROCCO DB



DISC BRAKE WHEELS

With the arrival of disc brakes into the ranks of not only the professional peloton but also amongst competitive and passionate cyclists all over the world, the demand for a disc brake wheelset truly worthy of the Campagnolo® name made the development of such a wheel a necessity.

As a result, Campagnolo® engineers have worked tirelessly to create wheels those will come to represent the same standard for quality and performance as its rim-brake counterpart.

As disc brake transmissions become ever more popular, many brands have rushed to improvise disc brake wheelsets by simply taking the rims from their rim-brake offering and lacing them to disc brake hubs. Campagnolo® regards this as a compromise in performance, reliability and product integrity.

In fact, for the front wheel the braking forces on the disc side require an additional structural design. Just as occurs in the rear wheel, the asymmetric forces are combatted by using the G3™ spoke design. The front wheel utilises the double spokes on the disc side.

With the incorporation of Mega-G3™ spoke pattern, the hub manages the asymmetric forces generated by the disc brakes.



Modified version of the famous G3™ spoke pattern on the rear wheel

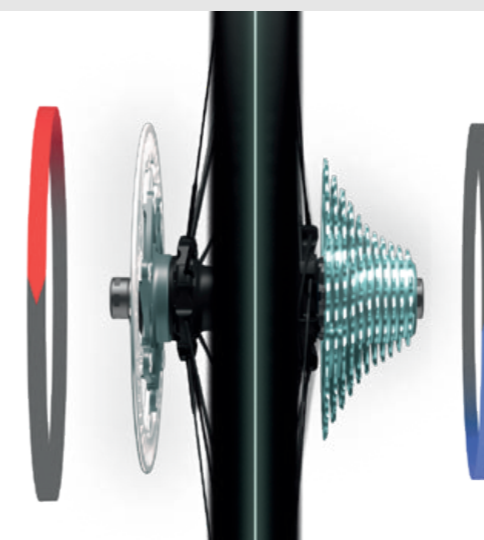

One piece solid construction to compensate for asymmetric forces from disc brakes



Modified version of the famous G3™ spoke pattern on the front wheel



2-WAY FIT™

2-WAY FIT™ READY

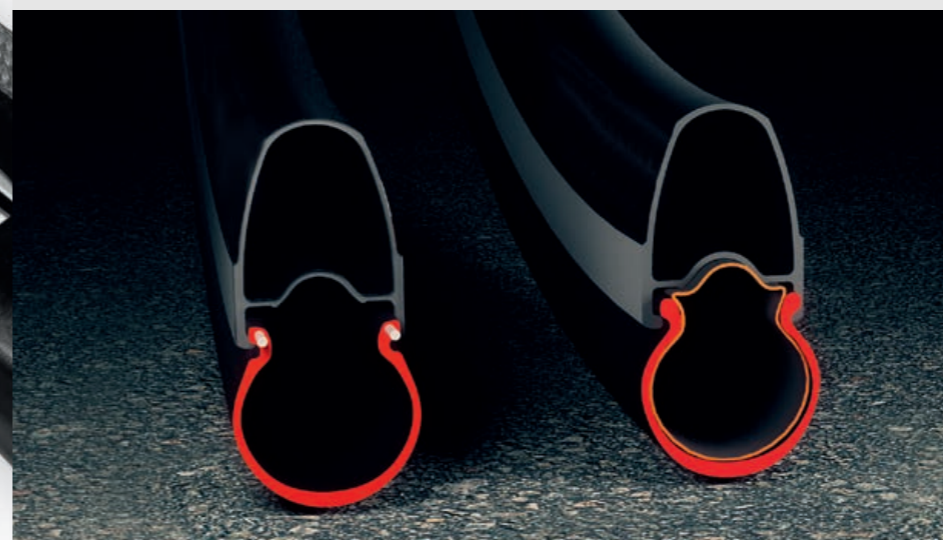

2-Way Fit™ technology makes it possible to mount either tubeless or clincher tires on the same rim.

With 2-Way Fit™ Campagnolo® customers can decide on any given day to use either clincher or tubeless tires as the wheel is perfectly compatible with both systems.

With no doubt tubeless tires are the future of road cycling. Apart from greater comfort, the advantages are many: using a tubeless tire you can exploit the greater smoothness due to the absence of friction between the tire and the tube.

And what if the tubeless tire has a puncture? The Campagnolo® 2-Way Fit™ system allows you to use a traditional inner tube by simply removing the hermetic closure valve to ride home with no problem.

The tubeless tire does not have an inner tube and consequently there is no risk of sudden deflation due to punctures.

The tubeless tire rolls more smoothly thanks to the absence of friction between tire and inner tube.



2-Way Fit™ Ready

Scirocco Disc Brake wheel can be converted in a 2-Way Fit™ Ready. Only the Tubeless Easy (TL-Easy) tyres by Schwalbe Pro One and G-One have been tested and approved for the Tubeless Easy conversion with the Campagnolo 2-Way Fit™ Ready profile.



AC3™ All Conditions Carbon Control

Campagnolo® has developed the All Conditions Carbon Control, or AC3™ Technology. The introduction of the meticulously researched textured design of the rim brake area of the Bora™ wheels creates a surefooted stopping power that is reliable and potent no matter what the weather will throw at you.



CULT™ Ceramic Ultimate Level Technology

Technologically advanced superior quality ceramic bearings in addition to the precision machining of the cup/cone structure and absence of grease drastically reduce friction and increase the smoothness of the wheel by as much as 5,5 times when compared to standard bearings. An outstanding result achieved by using cutting-edge technologies of materials processing.



USB™ Ceramic Ultra Smooth Bearings

The hubs with USB™ (Ultra Smooth Bearings) ceramic bearings increase smoothness, decrease rolling resistance, reduce weight and reduce the need for maintenance. Comparative tests have shown that USB™ bearings are 50% smoother than standard bearings. Now improving your performance during the race will be easier.

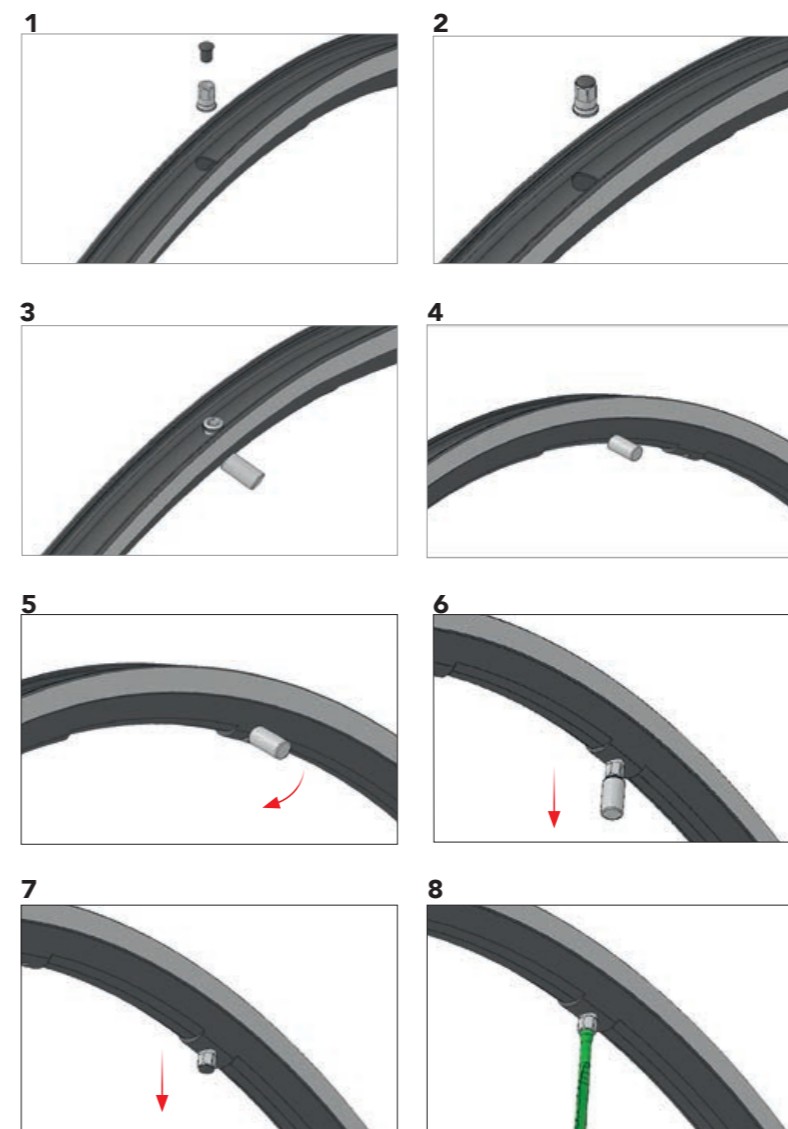

MoMag™

What is MoMag?

A technology that offers several advantages to the structural integrity of the wheel as well as eliminating the need for rim tape. The name derives from "Mounting Magnet" system, shortened to MoMag™.

The nipples, once inserted inside the rim via the valve hole, are "guided" to the point of connection with the spoke by means of the magnet. This simple but ingenious system makes it possible to have a wheel without holes on the upper bridge, but with spokes tensioned by traditional nipples!

No holes on the rim means that the rim is uniform at every point, free from stress points or zones of weakness and, for the clincher profiles no rim tape is required, to the benefit of weight reduction. The advantages are clear: greater rim lifetime, greater resistance to fatigue, the possibility to give the spokes greater tension, and greater stiffness which, in terms of performance, mean greater reactivity and acceleration. The advantages also include quick and simple maintenance and spoke replacement.

Spoke Antirotation System

The Bora™, Shamal™, Zonda™ and Scirocco™ wheels feature a spoke antirotation system patented by Campagnolo® that raises spoke performance to an unprecedented level.

Campagnolo® studied a system that would keep the spokes always in the exact identical position. This means that the spokes do not rotate, so there is no loss of tension during use and the aerodynamic penetration is not compromised.



MEGA-G3™

G3™ geometry: we have reinvented the wheel ... not just its look.

Campagnolo® has developed an assembly architecture which, compared with a traditional wheel, makes it possible to improve energy transfer, reduce the stress on the spokes on the right and increase transverse rigidity. This is achieved because in G3™ geometry the right-hand side of the rear wheel is fitted with twice as many spokes as the left.

The results of G3™ system are truly extraordinary: better transfer of the driving torque, better lateral rigidity, reduction of the stress in the rear wheel spokes. And thanks to the G3™ system that compensates for the forces acting on the 2 sides of the wheel, there are no more wheel vibrations, even for heavier people.

In 2014 G3™ becomes Mega-G3™ thanks to the oversize flange and an increase in lateral and torsional stiffness results.



Rim Dynamic Balance™

The concept is simple and elegant: balance the weight of the gasket, with an item of similar weight placed on the exact opposite side. For top aluminum models, this is obtained by a special operation on the section of the rim opposite the rim joint.

For carbon wheels the principle is the same, but applied using a different technology. When making carbon rims, the pieces of carbon fabric are aligned in such a manner that the resulting rim is always balanced.

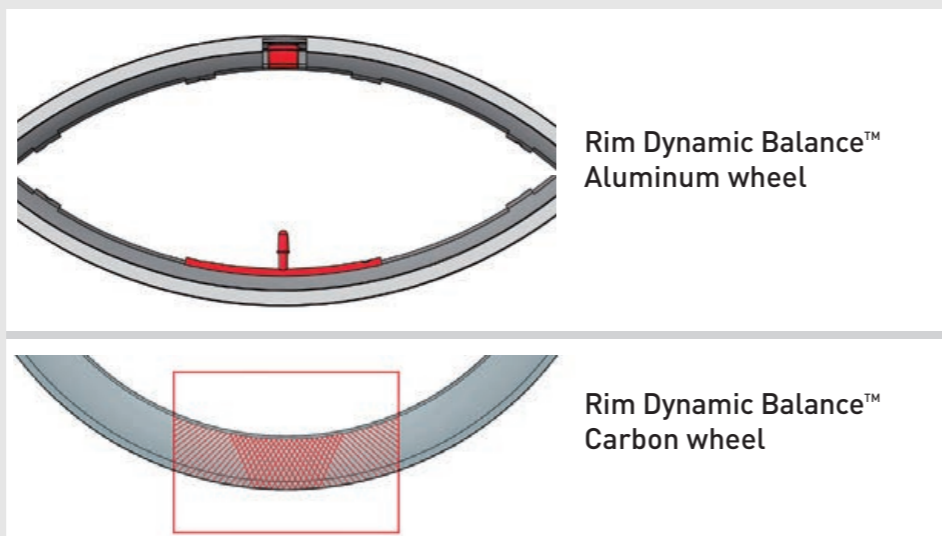

Rim Dynamic Balance™ Aluminum wheel

Rim Dynamic Balance™ Carbon wheel

CAMPAGNOLO® QUICK RELEASE

The Campagnolo® Quick Release is more than just a wheel retention system that acts as an axle. It is highly symbolic as it is the single piece from which the long and glorious history of Campagnolo® was born. The company's objective of continuously innovating to improve the cycling experience started with the quick release and it remains a functional and necessary symbol to this creed even now. Maximum performance in terms of assembly/disassembly ease, weight and smoothness of the wheel without compromising safety in any way.

The patented Campagnolo® mechanism is the one that best meets these needs. The lever is positioned centrally with respect to the axis of the hub axle, i.e. in the best position to put both ends of the axle in traction without differences in load between the sides. The axle is in the form of a cam and applies the closure traction on the axis of the quick release.

Thanks to the cam axle closure, it is simple and intuitive to understand the force to be applied for correctly closing the quick release and, even more importantly, the cam creates a mechanical impediment to the opening of the release, making it extremely safe during road use.

The fork positioned symmetrically with respect to the sides of the lever and centrally with respect to the axis of the skewer, enables an even distribution of the loads and forces at each point of the skewer, thus avoiding critical breakage points and at the same time perfect closure of the fork of the frame and the wheel. The symmetry of the lever and the special shape of the cam make locking and releasing the wheel extremely easy, fluid, and safe. The new aerodynamic form, moreover, considerably improves the aerodynamic coefficient of the range of wheels dedicated to time trial disciplines.



CARBON WHEELS

- BORA™ ULTRA™ TT
- BORA™ WTO 77
- BORA™ WTO 60
- BORA™ WTO 45
- BORA™ WTO 33

ALUMINIUM WHEELS

- SHAMAL™ ULTRA™
- ZONDA™
- SCIROCCO™
- CALIMA™

				•
				•
				•
				•
				•
			•	
		•		
		•		
	•			

Campagnolo® Identification Card

In order to leave you with absolutely no doubt as to the quality of the wheel purchased, Campagnolo® has implemented the Campagnolo® Identification Card (CIC) program. The CIC program sees a card that uniquely identifies each individual wheel and is manually compiled to guarantee that all tests have been done and that quality is guaranteed.

Only through in-depth inspection, both manual and digital, of each and every piece of every final product that leaves the premises can we be 100% sure of the exact same quality for each and every wheel that bears the Campagnolo® name.

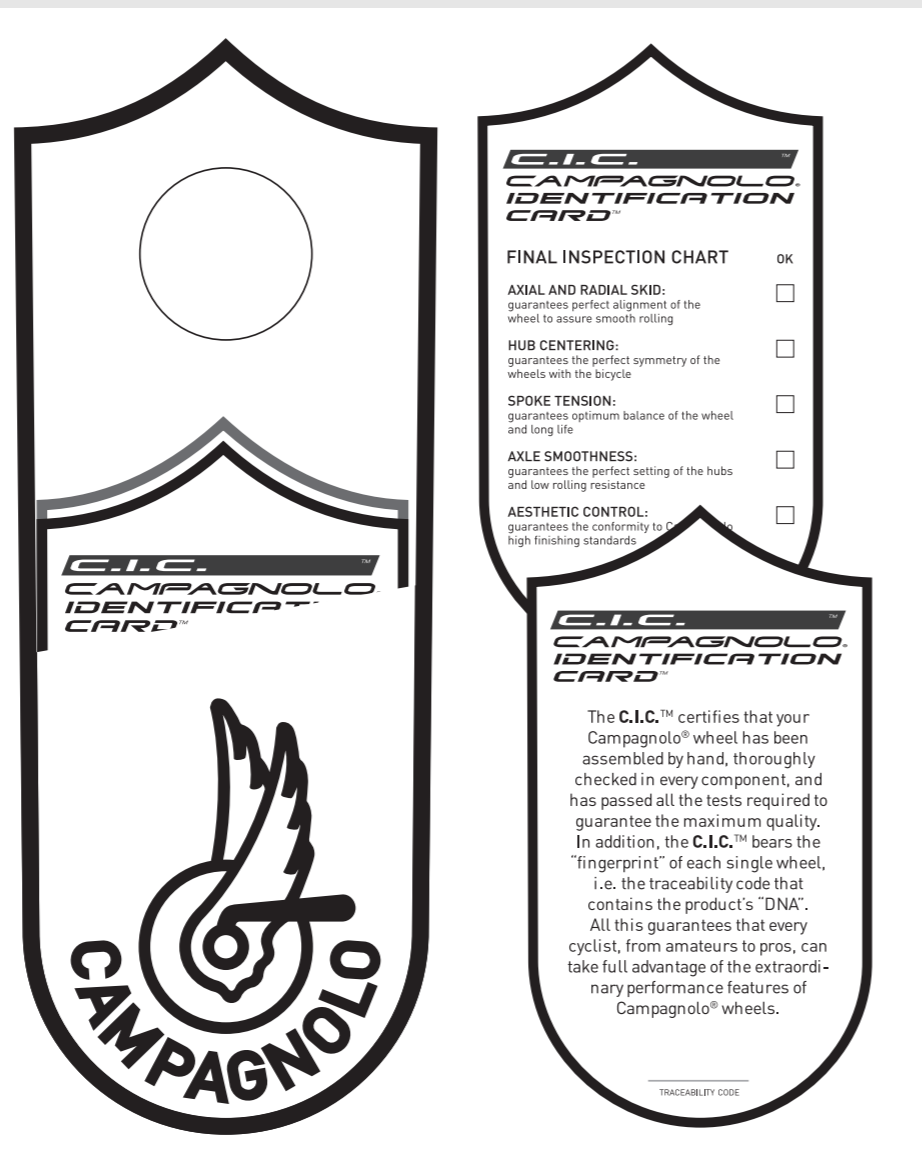

Traceability

The keyword for our products is: traceability.

If you find a little label affixed to Campagnolo® products, don't remove it. This is because it is there to provide you with a guarantee that in the event of the ascertained defectiveness of a production batch your component or wheel will be traceable. All this because, faithful to its mission, Campagnolo® demands absolute perfection and safety for its customers.



Campagnolo® and Certilogo® against counterfeiting: a tangible answer that protects our clients' safety and purchases.

Top-end Campagnolo® wheels are considered by the market and by aficionados to be reference products and as such are highly desirable. They have therefore also become appetizing to counterfeiters who have cloned some of our models (especially those in carbon fiber) releasing considerable numbers onto the international markets.

The wheel is a performance product, but also a safety component. This aspect means that those who purchase a fake product, while saving money on something that clearly costs much less than the going market price, puts their personal safety at great risk. The materials and production processes that together help to achieve a safe performing product are obviously not the same.

With the aim of fighting and combating these counterfeiters, Campagnolo® is the first in the cycling sector to have put in place, thanks to the support of Certilogo®, a control system that enables our clients to authenticate the product simply and immediately.



Starting with the products in the 2015 catalogue, each pair of Campagnolo® wheels in the Bora™ and Hyperon™ lines comes with an individual ID code (the Certilogo® Code or CLG Code) on a swing tag attached to a spoke on the wheel and, from July 2018, on a sticker to the rear wheel.



The Certilogo® Code (in both numerical and QR code) allows anyone, before or after purchase to check that the product is authentic. To authenticate Campagnolo® wheels, just visit www.certilogo.com, insert the CLG Code or download the Certilogo APP.

We suggest you keep the Campagnolo® Original Wheels tag even after product authentication for possible future use and, for wheels bought from July 2018 on, leaving the sticker with the Certilogo Code on the wheel.



PERFORMANCE/AERO CARBON WHEELS

The efficient wheelset must overcome resistance that comes in three specific forms: aerodynamic resistance, rolling resistance and resistance related to weight and gradient. The BORA™ WTO (Wind Tunnel Optimized) Project has given the Campagnolo® engineers a wealth of knowledge that has put them in a position to produce the new standard in efficient racing wheels. The new AERODYNAMIC standard for performance carbon wheels has a new name: BORA™ WTO. The WTO wheels have been optimized to ensure that every single part of their construction offers the most efficient form and structure. Not only a highly sophisticated and extremely aerodynamic form for the carbon fiber rim but also its hub and spokes make WTO the most efficient wheel available. If you are looking for the best in terms of aerodynamics and efficiency, look no further.

BORA™ ULTRA WTO TT	Disc Brake	119
BORA™ ULTRA WTO 80	Disc Brake	120
BORA™ ULTRA WTO 60	Disc Brake	121
BORA™ ULTRA WTO 45	Disc Brake	122
BORA™ ULTRA WTO 33	Disc Brake	123
BORA™ ULTRA TT	Rim Brake	124
BORA™ WTO 77	Rim Brake	125
BORA™ WTO 60	Disc Brake	126
BORA™ WTO 60	Rim Brake	127
BORA™ WTO 45	Disc Brake	128
BORA™ WTO 45	Rim Brake	129
BORA™ WTO 33	Disc Brake	130
BORA™ WTO 33	Rim Brake	131

#THEBEAUTYOF SPEED



INTRODUCING THE BORA™ ULTRA WTO

Stiffer, lighter and more aerodynamic, the new Bora™ Ultra WTO series showcases *the beauty of speed*.

Since 1994, Campagnolo's Bora™ series has set the standard for high-performance racing wheels, with each evolution bringing considerable real-world performance increases.

Campagnolo® now unveils its latest iteration in the range, the new Bora™ Ultra WTO series, a range-topping wheelset available disc brake-only, in 33, 45, 60 and 80mm rim-depth formats.

The new model takes an evolutionary leap ahead of its predecessors, with significant improvements to aerodynamics, stiffness and weight, unlocked by a forward-thinking design process at the brand's Vicenza HQ.

NEW

The Bora™ Ultra™ TT has always accompanied the greatest chrono men in cycling in their attempts to win international time trial medals. In 2022, the Campagnolo road lenticular wheel has been further innovated, maintaining its main characteristics of lightness and stiffness even in the new configuration for disc brakes. Its notes and extraordinary performance have now been adapted and implemented to fit any top-end bike with the highest expression of Campagnolo technology. The Bora™ Ultra™ WTO TT DB will accompany you in time trials, helping you gain a valuable advantage with every pedal stroke.

RIGHT SIDE

LEFT SIDE



2-Way Fit™: 1050 g

DISC BRAKE PROJECT

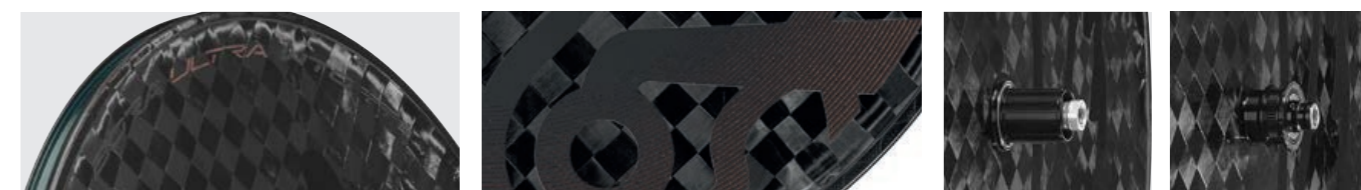

DEVELOPED ENTIRELY TO FIT DISC BRAKES AND MAINTAIN THE HIGH LEVELS OF STIFFNESS

that have always distinguished all Campagnolo lenticular wheels.

ENTIRELY IN HIGH MODULUS CARBON:

the rim in unidirectional carbon guarantees typical Campagnolo rideability.

IT DOES AWAY WITH ANY FLECTION EFFECTS, ESPECIALLY CLOSE TO THE BOTTOM BRACKET

THE 19 MM BED ALLOWS FOR BETTER AIR PENETRATION AT HIGH SPEEDS

ITS INNOVATIVE DESIGN AIMS TO REDUCE PROFILE DIMENSIONS TO A MINIMUM

IT GUARANTEES CONSIDERABLY IMPROVED AERODYNAMICS FOR THE BIKE AS A WHOLE

GRAPHICS FEATURING THE "WINGED WHEEL": the legendary Campagnolo® "Winged Wheel" logo identifies Campagnolo® lenticular wheels that use the very latest carbon fiber technologies.



BEARINGS WITH CULT™ TECHNOLOGY: the combination between the highest quality ceramic bearings and housing in special steel. CULT™ bearings have a friction coefficient 40% lower than standard sealed bearings, and in tests, can spin for 5 1/2 times longer.

CUP AND CONE BEARINGS: easy bearing adjustment – reduces the possibility bearing play – precision operation – maintains performance over time.

LIGHTWEIGHT AND EXTREMELY RIGID ALUMINUM HUB CONSTRUCTION

CASSETTE: compatible with Campagnolo® 10, 11 and 12 speed cassettes as well as Shimano Inc. 9, 10, and 11 speed cassettes.

CORPETTI R/L DISPONIBILI: Campagnolo N3W™ - HG - XDR

The Bora™ Ultra WTO 80 was created to turn every single watt into pure speed. Its 80 mm profile was chosen after in-depth studies and careful calculations to ensure the best balance of weight, aerodynamic efficiency and simple wheel steering. Constructed with Campagnolo's Hand Made Ultra-light carbon (H.U.L.C.), the rims feature a mirror-like Campagnolo Luxury (C-LUX) finish and 2-Way Fit™ rim beds with no drilled holes, ensuring perfect tire compatibility without the need for rim-tape. The brand new aero spokes with internal nipples reduce aerodynamic resistance while ceramic CULT™ bearings reduce friction to a minimum. Like all Bora™ Ultra wheels, there are no drilled holes in the rim bed, making tubeless tires easy to fit and hugely increasing rim stiffness and integrity. The Bora™ Ultra WTO 80 is the new benchmark for high-profile wheels suitable for time trials and high-speed stages.

REAR WHEEL

FRONT WHEEL



2-Way Fit™: 1590 g

DISC BRAKE PROJECT

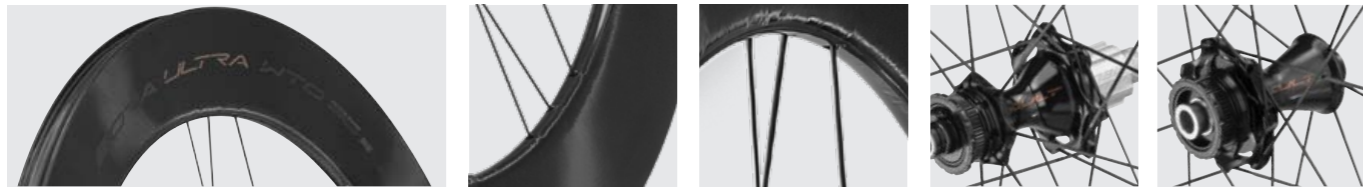

EXTREMELY AERODNAMIC FULL CARBON FIBER RIM, 27 mm WIDE, COMPATIBLE WITH BOTH TUBELESS AND CLINCHER TIRES:

Wind Tunnel Optimized to be extremely efficient. Campagnolo® construction to ensure reactivity and reliability.

C-LUX FINISH:

C-LUX creates the same high gloss surface finish on all external faces of the rim, including the rim bed and tyre hooks. By guaranteeing a more precise wheel diameter, and ensuring the safety elements are perfectly formed, we are able to promise easier assembly and, by improving their match with the rim interface, tubeless tyres will seal better, conform more easily when rolling, and should last longer.

H.U.L.C. CONSTRUCTION:

the Bora™ Ultra WTO rims are the lightest that Campagnolo® have ever made in each depth, thanks to the new Handmade Ultra-Light Carbon (H.U.L.C.) process. H.U.L.C. optimises the moulding profiles, and the quantity of carbon fibre and proprietary resin used.

WIND TUNNEL OPTIMIZED 3D SPOKE DESIGN: aerodynamic shape from all angles.

G3™ SPOKE PATTERN:

Campagnolo's asymmetric G3™ system, optimised for disc brakes, improves power transfer and reduces stress during sprinting as well as under heavy braking.

AERO MO-MAG:

the innovative Mo-Mag system allowed external spoke nipples to be positioned from inside the rim using a magnet, with no need to create additional holes in the rim bed for them. Aero Mo-Mag takes it a step further, with a completely internal, hidden system, which maximises aerodynamics, and allows the rim to be built lighter.



BEARINGS WITH CULT™ TECHNOLOGY:

the combination between the highest quality ceramic bearings and housing in special steel. CULT™ bearings have a friction coefficient 40% lower than standard sealed bearings, and in tests, can spin for 5 ½ times longer.

ADJUSTING LOCKING WITH MICRO-SETTING: for precision hub adjustment.

ALUMINIUM REAR HUB SHELL:

permits an improved torque transfer across hub during the braking phase.

CARBON FIBRE FRONT HUB:

Campagnolo's beautifully moulded carbon fibre front hub body is hourglass shaped to improve aerodynamics, and is securely bonded to a light aluminium hub flange.

AVAILABLE F/W BODIES:

Campagnolo N3W™ - HG - XDR

The Bora™ Ultra WTO 60 exists to turn every last watt in to pure speed. Its impressively light weight and efficiency ensure that you not only reach the finish in contention, but also have the ultimate tool to emerge victorious. The advanced, wind tunnel optimised profile of its 60mm deep carbon rim, promises sharp, confident handling in all conditions. All-new aero spokes with hidden nipples reduce aerodynamic drag, while CULT™ ceramic bearings minimise friction. Campagnolo's beautifully moulded carbon front hub body is securely bonded to a light aluminium hub flange, and integrated radial spoke seats ensure perfect alignment. The rim bed is undrilled, making tubeless installation simple, and seriously increasing the rim's integrity and torsional rigidity. It's a sprinter's, rouleur's and time triallist's dream.

REAR WHEEL

FRONT WHEEL



2-Way Fit™: 1530 g

DISC BRAKE PROJECT



EXTREMELY AERODNAMIC FULL CARBON FIBER RIM, 26,1 mm WIDE, COMPATIBLE WITH BOTH TUBELESS AND CLINCHER TIRES:

Wind Tunnel Optimized to be extremely efficient. Campagnolo® construction to ensure reactivity and reliability.

C-LUX FINISH:

C-LUX creates the same high gloss surface finish on all external faces of the rim, including the rim bed and tyre hooks. By guaranteeing a more precise wheel diameter, and ensuring the safety elements are perfectly formed, we are able to promise easier assembly and, by improving their match with the rim interface, tubeless tyres will seal better, conform more easily when rolling, and should last longer.

H.U.L.C. CONSTRUCTION:

the Bora™ Ultra WTO rims are the lightest that Campagnolo® have ever made in each depth, thanks to the new Handmade Ultra-Light Carbon (H.U.L.C.) process. H.U.L.C. optimises the moulding profiles, and the quantity of carbon fibre and proprietary resin used.

WIND TUNNEL OPTIMIZED 3D SPOKE DESIGN: aerodynamic shape from all angles.

G3™ SPOKE PATTERN:

Campagnolo's asymmetric G3™ system, optimised for disc brakes, improves power transfer and reduces stress during sprinting as well as under heavy braking.

AERO MO-MAG:

the innovative Mo-Mag system allowed external spoke nipples to be positioned from inside the rim using a magnet, with no need to create additional holes in the rim bed for them. Aero Mo-Mag takes it a step further, with a completely internal, hidden system, which maximises aerodynamics, and allows the rim to be built lighter.



BEARINGS WITH CULT™ TECHNOLOGY:

the combination between the highest quality ceramic bearings and housing in special steel. CULT™ bearings have a friction coefficient 40% lower than standard sealed bearings, and in tests, can spin for 5 ½ times longer.

ADJUSTING LOCKING WITH MICRO-SETTING: for precision hub adjustment.

ALUMINIUM REAR HUB SHELL:

permits an improved torque transfer across hub during the braking phase.

CARBON FIBRE FRONT HUB:

Campagnolo's beautifully moulded carbon fibre front hub body is hourglass shaped to improve aerodynamics, and is securely bonded to a light aluminium hub flange.

AVAILABLE F/W BODIES:

Campagnolo N3W™ - HG - XDR

Campagnolo's Bora™ Ultra WTO 45 has the perfect balance of speed, agility and stability, making it the best choice for all-round riders. The rim's versatile design takes account of real-world riding conditions, not just those created in a wind tunnel, and the result is the most efficient drag-reducing rim shape available.

Now even lighter, thanks in part to its Hand Made Ultra-Light Carbon (H.U.L.C.) construction, the Bora™ Ultra WTO 45 has slimmer Aero Elliptical spokes and hidden nipples to help slice through the air. Campagnolo's beautifully moulded carbon front hub body is securely bonded to a light aluminium hub flange, and integrated radial spoke seats ensure perfect alignment. A uniquely stunning C-LUX finish and new, subtle Bora™ Ultra WTO graphics ensure the new wheels have the show to match their go.

REAR WHEEL

FRONT WHEEL



2-Way Fit™: 1425 g

DISC BRAKE PROJECT



EXTREMELY AERODNAMIC FULL CARBON FIBER RIM, 26,1 mm WIDE, COMPATIBLE WITH BOTH TUBELESS AND CLINCHER TIRES:

Wind Tunnel Optimized to be extremely efficient. Campagnolo® construction to ensure reactivity and reliability.

C-LUX FINISH:

C-LUX creates the same high gloss surface finish on all external faces of the rim, including the rim bed and tyre hooks. By guaranteeing a more precise wheel diameter, and ensuring the safety elements are perfectly formed, we are able to promise easier assembly and, by improving their match with the rim interface, tubeless tyres will seal better, conform more easily when rolling, and should last longer.

H.U.L.C. CONSTRUCTION:

the Bora™ Ultra WTO rims are the lightest that Campagnolo® have ever made in each depth, thanks to the new Handmade Ultra-Light Carbon (H.U.L.C.) process. H.U.L.C. optimises the moulding profiles, and the quantity of carbon fibre and proprietary resin used.

WIND TUNNEL OPTIMIZED 3D SPOKE DESIGN: aerodynamic shape from all angles.

G3™ SPOKE PATTERN:

Campagnolo's asymmetric G3™ system, optimised for disc brakes, improves power transfer and reduces stress during sprinting as well as under heavy braking.

AERO MO-MAG:

the innovative Mo-Mag system allowed external spoke nipples to be positioned from inside the rim using a magnet, with no need to create additional holes in the rim bed for them. Aero Mo-Mag takes it a step further, with a completely internal, hidden system, which maximises aerodynamics, and allows the rim to be built lighter.



BEARINGS WITH CULT™ TECHNOLOGY:

the combination between the highest quality ceramic bearings and housing in special steel. CULT™ bearings have a friction coefficient 40% lower than standard sealed bearings, and in tests, can spin for 5 ½ times longer.

ADJUSTING LOCKING WITH MICRO-SETTING: for precision hub adjustment.

ALUMINIUM REAR HUB SHELL:

permits an improved torque transfer across hub during the braking phase.

CARBON FIBRE FRONT HUB:

Campagnolo's beautifully moulded carbon fibre front hub body is hourglass shaped to improve aerodynamics, and is securely bonded to a light aluminium hub flange.

AVAILABLE F/W BODIES:

Campagnolo N3W™ - HG - XDR

Climbers will love the Bora™ Ultra WTO 33's lower weight, helping them to reach the heights even faster, change pace instantly, and descend with great speed and confidence. Built using Campagnolo's Hand Made Ultra-Light Carbon (H.U.L.C.), the rims have Campagnolo's mirror-like Luxury (C-LUX) finish, and undrilled 2-Way Fit™ rim beds, for perfect tubeless compatibility without rim tape. Campagnolo's beautifully moulded carbon fibre front hub body is hourglass shaped to improve aerodynamics, and is securely bonded to a light aluminium hub flange. Integrated radial spoke seats ensure perfect alignment, hidden Aero Mo-Mag™ nipples and slimmer Aero Elliptical spokes in Campagnolo's G3™ spoke pattern further enhance performance, and its CULT™ ceramic bearings promise almost frictionless rotation.

REAR WHEEL

FRONT WHEEL



2-Way Fit™: 1385 g

DISC BRAKE PROJECT



EXTREMELY AERODNAMIC FULL CARBON FIBER RIM, 24,7 mm WIDE, COMPATIBLE WITH BOTH TUBELESS AND CLINCHER TIRES:

Wind Tunnel Optimized to be extremely efficient. Campagnolo® construction to ensure reactivity and reliability.

C-LUX FINISH:

C-LUX creates the same high gloss surface finish on all external faces of the rim, including the rim bed and tyre hooks. By guaranteeing a more precise wheel diameter, and ensuring the safety elements are perfectly formed, we are able to promise easier assembly and, by improving their match with the rim interface, tubeless tyres will seal better, conform more easily when rolling, and should last longer.

H.U.L.C. CONSTRUCTION:

the Bora™ Ultra WTO rims are the lightest that Campagnolo® have ever made in each depth, thanks to the new Handmade Ultra-Light Carbon (H.U.L.C.) process. H.U.L.C. optimises the moulding profiles, and the quantity of carbon fibre and proprietary resin used.

WIND TUNNEL OPTIMIZED 3D SPOKE DESIGN: aerodynamic shape from all angles.

G3™ SPOKE PATTERN:

Campagnolo's asymmetric G3™ system, optimised for disc brakes, improves power transfer and reduces stress during sprinting as well as under heavy braking.

AERO MO-MAG:

the innovative Mo-Mag system allowed external spoke nipples to be positioned from inside the rim using a magnet, with no need to create additional holes in the rim bed for them. Aero Mo-Mag takes it a step further, with a completely internal, hidden system, which maximises aerodynamics, and allows the rim to be built lighter.



BEARINGS WITH CULT™ TECHNOLOGY:

the combination between the highest quality ceramic bearings and housing in special steel. CULT™ bearings have a friction coefficient 40% lower than standard sealed bearings, and in tests, can spin for 5 ½ times longer.

ADJUSTING LOCKING WITH MICRO-SETTING: for precision hub adjustment.

ALUMINIUM REAR HUB SHELL:

permits an improved torque transfer across hub during the braking phase.

CARBON FIBRE FRONT HUB:

Campagnolo's beautifully moulded carbon fibre front hub body is hourglass shaped to improve aerodynamics, and is securely bonded to a light aluminium hub flange.

AVAILABLE F/W BODIES:

Campagnolo N3W™ - HG - XDR

Since its introduction, the Bora™ Ultra™ TT has accompanied cyclists of the highest caliber in winning international medals in time trials. In 2017, despite such success, the Campagnolo® road lenticular wheel was innovated even further, improving upon its main characteristics of low weight and extreme stiffness. The new Bora™ Ultra™ TT in fact weighs nearly 111 g less than the previous model and is 8% stiffer than the stiffest competitor's wheel. The Campy Tech Lab™ has focused additionally on creating a product that meets the needs of time trial bike braking systems and the results are impressive. The 2018 range saw the addition of the AC3™ (All Conditions Carbon Control) Technology braking surface, which brings braking performance in wet conditions closer to that found on dry conditions.

RIGHT SIDE

LEFT SIDE



Tubular: 864 g



WHEEL DEVELOPED FOR THE TIME TRIAL FRAME:

extremely stiff structure further eliminates flex near the bottom bracket, namely where the rear brake is positioned on most time trial frames, thus avoiding any possible friction with the brake itself.

FULL HIGH MODULOUS CARBON RIM FOR TUBULAR

AC3™ (ALL CONDITIONS CARBON CONTROL) BRAKING SURFACE TECHNOLOGY: improves the braking performances on dry and, above all, on wet conditions.

BRAKE PADS MADE ESPECIALLY FOR CARBON WHEELS:

the special blend increases the brake performance on both dry and wet surfaces without increasing the wear and tear on the pad or wheel.

FULL CARBON DISC IN A SPECIALLY DEVELOPED WEAVE

PROFILE: extreme new design reduces profile on both drive and non-drive sides for an even slimmer and more aerodynamic design.

GRAPHICS FEATURING THE "WINGED WHEEL": the legendary Campagnolo® "Winged Wheel" logo identifies Campagnolo® lenticular wheels that use the very latest carbon fiber technologies.



BEARINGS WITH CULT™ TECHNOLOGY: the combination between the highest quality ceramic bearings and housing in special steel. CULT™ bearings have a friction coefficient 40% lower than standard sealed bearings, and in tests, can spin for 5 ½ times longer.

CUP AND CONE BEARINGS: easy bearing adjustment – reduces the possibility bearing play – precision operation – maintains performance over time.

LIGHTWEIGHT AND EXTREMELY RIGID ALUMINIUM HUB CONSTRUCTION

CASSETTE: compatible with Campagnolo® 10, 11 and 12 speed cassettes as well as Shimano Inc. 9, 10, and 11 speed cassettes.

Bora™ has become the benchmark in the carbon race wheel sector for many reasons, including reactivity, handling, lightness and reliability. Still, it is the wind, or better said, the penetration of the wind that gives the wheel its name since aerodynamics is an essential part of its performance. With the Bora™ WTO (Wind Tunnel Optimized) project, the Campy Tech Lab dedicated all of its energy on further improving aerodynamic efficiency, pushing the boundaries once again. Today, the result achieved by this task force is called the Bora™ WTO 77. Every element of this wheel was designed completely from scratch and it has become the fastest front wheel on the market.

REAR WHEEL
Bright label

FRONT WHEEL
Bright label



2-Way Fit™: 755 g



EXTREMELY AERODNAMIC FULL CARBON FIBER RIM, 26.5mm WIDE, COMPATIBLE WITH BOTH TUBELESS AND CLINCHER TIRES:

Wind Tunnel Optimized to be extremely efficient. Campagnolo construction to ensure reactivity and reliability.

AC3™ (ALL CONDITIONS CARBON CONTROL) BRAKING SURFACE TECHNOLOGY: improves the braking performances on dry and, above all, on wet conditions.

100% HIGH MODULOUS CARBON FIBER: the unique, hand made construction allows Campagnolo staff to orient each and every fiber in accordance to a specific design. Every single fiber, from the inner most layers to the unidirectional fiber used for the external application are of high modulus and oriented in a way to ensure professional level ride quality. Robust, reliable and reactive the Bora wheels are also lightweight. No paint or clear coat needed as the rim's anti UV resin leaves a naturally pristine finish.

BRAKE PADS SPECIFIC FOR CARBON FIBER

WIND TUNNEL OPTIMIZED 3D SPOKE DESIGN: aerodynamic shape from all angles.

SELF-LOCKING NIPPLES: it allows to maintain the right tension of the spokes and does not require any maintenance.



BEARINGS WITH CULT™ TECHNOLOGY: the combination between the highest quality ceramic bearings and housing in special steel. CULT™ bearings have a friction coefficient 40% lower than standard sealed bearings, and in tests, can spin for 5 ½ times longer.

CONE/CUP BEARINGS SYSTEM: high-performance ceramic bearings teamed with the cone/cup system ensure long-lasting performance, make adjustment easier, reduce possible play and improve smoothness.

ALUMINIUM HUB STRUCTURE, LIGHT AND EXTREMELY RIGID AND AERODYNAMIC: optimised in the wind tunnel and designed for optimal rigidity and weight.

ALUMINIUM AXLE reduces the weight of the wheel.

Campagnolo introduces its first aerodynamic disc brake wheel with a 60 mm profile, designed to appeal to cyclists with a love for speed. Its high profile can transfer all the aerodynamic advantages acquired from our research and development study to the road. The wheel features unidirectional carbon rims with a rounded-profile optimised in the wind tunnel, new aerodynamic aluminium hubs and the ceramic USB cup-and-cone bearing system. The profile of the rim, which has an internal width of 19 mm, makes a perfect pairing with 23, 25 and 28 mm tyres. Thanks to 2-Way Fit technology, Campagnolo guarantees complete compatibility with both clincher and tubeless tyres. Available versions: dark label, Campagnolo FW hub, HG or XDR.

Bora™ WTO 60 DB: made for winning in sprint finishes, circuit races, time trials and triathlons.

REAR WHEEL
Dark label

FRONT WHEEL
Dark label



2-Way Fit™: 1590 g

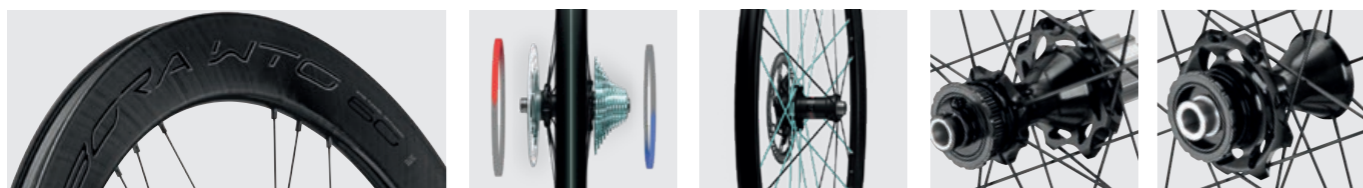

EXTREMELY AERODNAMIC FULL CARBON FIBER RIM, 26 mm WIDE, COMPATIBLE WITH BOTH TUBELESS AND CLINCHER TIRES:

Wind Tunnel Optimized to be extremely efficient. Campagnolo construction to ensure reactivity and reliability.

RDB™ RIM DYNAMIC BALANCE:

when manufacturing carbon rims, the carbon fibre is aligned in such a manner that the resulting rim is perfectly balanced.

100% HIGH MODULOUS CARBON FIBER:

the unique, hand made construction allows Campagnolo staff to orient each and every fiber in accordance to a specific design. Every single fiber, from the inner most layers to the unidirectional fiber used for the external application are of high modulus and oriented in a way to ensure professional level ride quality. Robust, reliable and reactive the Bora wheels are also lightweight. No paint or clear coat needed as the rim's anti UV resin leaves a naturally pristine finish.

WIND TUNNEL OPTIMIZED 3D SPOKE DESIGN: aerodynamic shape from all angles.

EXCLUSIVE G3™ SPOKE PATTERN:

perfect balance of spoke tension on both sides of the wheel. Reduces stress, increases transversal rigidity and the transmission of power to the wheel. G3™ eliminates vibrations even with "heavy" cyclists.

SELF-LOCKING NIPPLES:

it allows to maintain the right tension of the spokes and does not require any maintenance.



USB™ ULTRA SMOOTH BEARINGS:

top quality ceramic bearings create a perfectly smooth, resistance and maintenance free rolling.

ADJUSTING LOCKING WITH MICRO-SETTING:

for precision hub adjustment.

ALUMINIUM HUB SHELL:

permits an improved torque transfer across hub during the braking phase.

NEW FLANGE ROAD DESIGN:

allows integration with the AFS rotor on the braking force, transmission side.

AVAILABLE F/W BODIES:

Campagnolo - HG - XDR

With the new Bora™ WTO 60, Campagnolo has focused on producing the most efficient wheels possible in terms of decreasing rolling resistance as the cyclist moves and maximising aerodynamic efficiency. The acronym WTO - WIND TUNNEL OPTIMIZED - calls to mind the environment that the team of Campy Tech Lab engineers worked in to meet these challenging project objectives. The new Bora™ WTO 60 wheels feature exclusive design characteristics that establish new standards in aerodynamic efficiency. Directly from the wind tunnel to the market, the pair of Bora™ WTO 60 wheels is destined to become the necessary choice every time a cyclist faces a route that requires average speeds of more than 40 km/h.

REAR WHEEL
Bright label

FRONT WHEEL
Dark label



2-Way Fit™: 1547 g



EXTREMELY AERODNAMIC FULL CARBON FIBER RIM, 26.5mm WIDE, COMPATIBLE WITH BOTH TUBELESS AND CLINCHER TIRES:

Wind Tunnel Optimized to be extremely efficient. Campagnolo staff to orient each and every fiber in accordance to a specific design. Every single fiber, from the inner most layers to the unidirectional fiber used for the external application are of high modulus and oriented in a way to ensure professional level ride quality. Robust, reliable and reactive the Bora wheels are also lightweight. No paint or clear coat needed as the rim's anti UV resin leaves a naturally pristine finish.

AC3™ (ALL CONDITIONS CARBON CONTROL) BRAKING SURFACE TECHNOLOGY:

improves the braking performances on dry and, above all, on wet conditions.

100% HIGH MODULOUS CARBON FIBER:

the unique, hand made construction allows Campagnolo staff to orient each and every fiber in accordance to a specific design. Every single fiber, from the inner most layers to the unidirectional fiber used for the external application are of high modulus and oriented in a way to ensure professional level ride quality. Robust, reliable and reactive the Bora wheels are also lightweight. No paint or clear coat needed as the rim's anti UV resin leaves a naturally pristine finish.

BRAKE PADS SPECIFIC FOR CARBON FIBER

WIND TUNNEL OPTIMIZED 3D SPOKE DESIGN: aerodynamic shape from all angles.

EXCLUSIVE G3™ SPOKE PATTERN:

perfect balance of spoke tension on both sides of the wheel. Reduces stress, increases transversal rigidity and the transmission of power to the wheel. G3™ eliminates vibrations even with "heavy" cyclists.

SELF-LOCKING NIPPLES:

it allows to maintain the right tension of the spokes and does not require any maintenance.



USB™ CERAMIC BALL BEARINGS:

reduces friction, provides greater smoothness, and maintains performance over time.

CUP AND CONE BEARINGS:

easy bearing adjustment.

ALUMINIUM HUB STRUCTURE, LIGHT AND EXTREMELY RIGID AND AERODYNAMIC:

optimised in the wind tunnel and designed for optimal rigidity and weight.

ALUMINIUM AXLE

reduces the weight of the wheel.

OVERSIZED FLANGE:

greater torsional stiffness and greater reactivity.

Campagnolo® introduces the first aerodynamic Disc Brake wheel with a 45 mm profile, designed to appeal to a broader customer base. The design of the rim enables maximum aerodynamic penetration, and at certain angles, the wind can actually become a valuable ally to the rider. The wheel features carbon rims with a unidirectional aerodynamic finish, new aerodynamic aluminium hubs, and the ceramic USB™ cup-and-cone bearing system: every design choice has been made with a view to optimising performance. The profile of the rim, which has an internal diameter of 19 mm, corresponds perfectly with 23 mm, 25 mm and 28 mm tyres. While the key purpose of these wheels is to deliver extreme performance, safety is also guaranteed thanks to the G3™ spoking system with double spokes on the left of the front wheel, to ensure balanced and safe braking in all conditions. Available versions: dark label, Campagnolo® freewheel hub, HG or XDR.

REAR WHEEL
Dark label

FRONT WHEEL
Dark label



2-Way Fit™: 1520 g

DISC BRAKE
PROJECT



EXTREMELY AERODNAMIC FULL CARBON FIBER RIM, 26 mm WIDE, COMPATIBLE WITH BOTH TUBELESS AND CLINCHER TIRES:

Wind Tunnel Optimized to be extremely efficient. Campagnolo construction to ensure reactivity and reliability.

RDB™ RIM DYNAMIC BALANCE:

when manufacturing carbon rims, the carbon fibre is aligned in such a manner that the resulting rim is perfectly balanced.

100% HIGH MODULOUS CARBON FIBER:

the unique, hand made construction allows Campagnolo staff to orient each and every fiber in accordance to a specific design. Every single fiber, from the inner most layers to the unidirectional fiber used for the external application are of high modulus and oriented in a way to ensure professional level ride quality. Robust, reliable and reactive the Bora wheels are also lightweight. No paint or clear coat needed as the rim's anti UV resin leaves a naturally pristine finish.

WIND TUNNEL OPTIMIZED 3D SPOKE DESIGN:

aerodynamic shape from all angles.

EXCLUSIVE G3™ SPOKE PATTERN:

perfect balance of spoke tension on both sides of the wheel. Reduces stress, increases transversal rigidity and the transmission of power to the wheel. G3™ eliminates vibrations even with "heavy" cyclists.

SELF-LOCKING NIPPLES:

it allows to maintain the right tension of the spokes and does not require any maintenance.



USB™ ULTRA SMOOTH BEARINGS:

top quality ceramic bearings create a perfectly smooth, resistance and maintenance free rolling.

ADJUSTING LOCKING WITH MICRO-SETTING:

for precision hub adjustment.

ALUMINIUM HUB SHELL:

permits an improved torque transfer across hub during the braking phase.

NEW FLANGE ROAD DESIGN:

allows integration with the AFS rotor on the braking force, transmission side.

AVAILABLE F/W BODIES:

Campagnolo - HG - XDR

The family of carbon aero wheels is further enhanced with the 45 mm profile, designed to appeal to a broader customer base. The design of the rim enables maximum aerodynamic penetration, and at certain angles, the wind can actually become a valuable ally to the rider. Aerodynamic aluminium rims and hubs and ceramic USB™ cup-and-cone bearing system in the hubs themselves: every design choice has been made with a view to optimising performance.

The 19 mm internal diameter of the rim enables tyres of 23mm, 25mm and 28mm to be fitted. While the key purpose of these wheels is to deliver extreme performance, safety is also guaranteed by the Campagnolo® AC3™ (All Conditions Carbon Control) technology, which ensures safe, modular braking in all weather conditions. Available versions: bright and dark label, Campagnolo® FW or HG11 body.

REAR WHEEL
Bright label

FRONT WHEEL
Dark label



2-Way Fit™: 1496 g



EXTREMELY AERODNAMIC FULL CARBON FIBER RIM, 26.5mm WIDE, COMPATIBLE WITH BOTH TUBELESS AND CLINCHER TIRES:

Wind Tunnel Optimized to be extremely efficient. Campagnolo construction to ensure reactivity and reliability.

AC3™ (ALL CONDITIONS CARBON CONTROL) BRAKING SURFACE TECHNOLOGY:

improves the braking performances on dry and, above all, on wet conditions.

100% HIGH MODULOUS CARBON FIBER:

the unique, hand made construction allows Campagnolo staff to orient each and every fiber in accordance to a specific design. Every single fiber, from the inner most layers to the unidirectional fiber used for the external application are of high modulus and oriented in a way to ensure professional level ride quality. Robust, reliable and reactive the Bora wheels are also lightweight. No paint or clear coat needed as the rim's anti UV resin leaves a naturally pristine finish.

BRAKE PADS SPECIFIC FOR CARBON FIBER

WIND TUNNEL OPTIMIZED 3D SPOKE DESIGN:

aerodynamic shape from all angles.

EXCLUSIVE G3™ SPOKE PATTERN:

perfect balance of spoke tension on both sides of the wheel. Reduces stress, increases transversal rigidity and the transmission of power to the wheel. G3™ eliminates vibrations even with "heavy" cyclists.

SELF-LOCKING NIPPLES:

it allows to maintain the right tension of the spokes and does not require any maintenance.



USB™ CERAMIC BALL BEARINGS:

reduces friction, provides greater smoothness, and maintains performance over time.

CUP AND CONE BEARINGS:

easy bearing adjustment.

ALUMINIUM HUB STRUCTURE, LIGHT AND EXTREMELY RIGID AND AERODYNAMIC:

optimised in the wind tunnel and designed for optimal rigidity and weight.

ALUMINIUM AXLE

reduces the weight of the wheel.

OVERSIZED FLANGE:

greater torsional stiffness and greater reactivity.

Campagnolo introduces the first aerodynamic Disc Brake wheel with a 33 mm profile. It is a turning point in the all-rounder segment: a truly multi-purpose wheel.

The wheel features aerodynamic carbon rims with a unidirectional finish, new aerodynamic aluminium hubs, and the ceramic USB cup-and-cone bearing system: every design choice has been made with a view to optimizing performance.

The profile of the rim, which has an internal diameter of 19 mm, corresponds perfectly with 23 mm, 25 mm and 28 mm tyres.

Safety is guaranteed thanks to the G3 spoking system with double spokes on the left of the front wheel, to ensure balanced and safe braking in all conditions. Available versions: dark label, Campagnolo freewheel hub, HG or XDR

REAR WHEEL
Dark label

FRONT WHEEL
Dark label

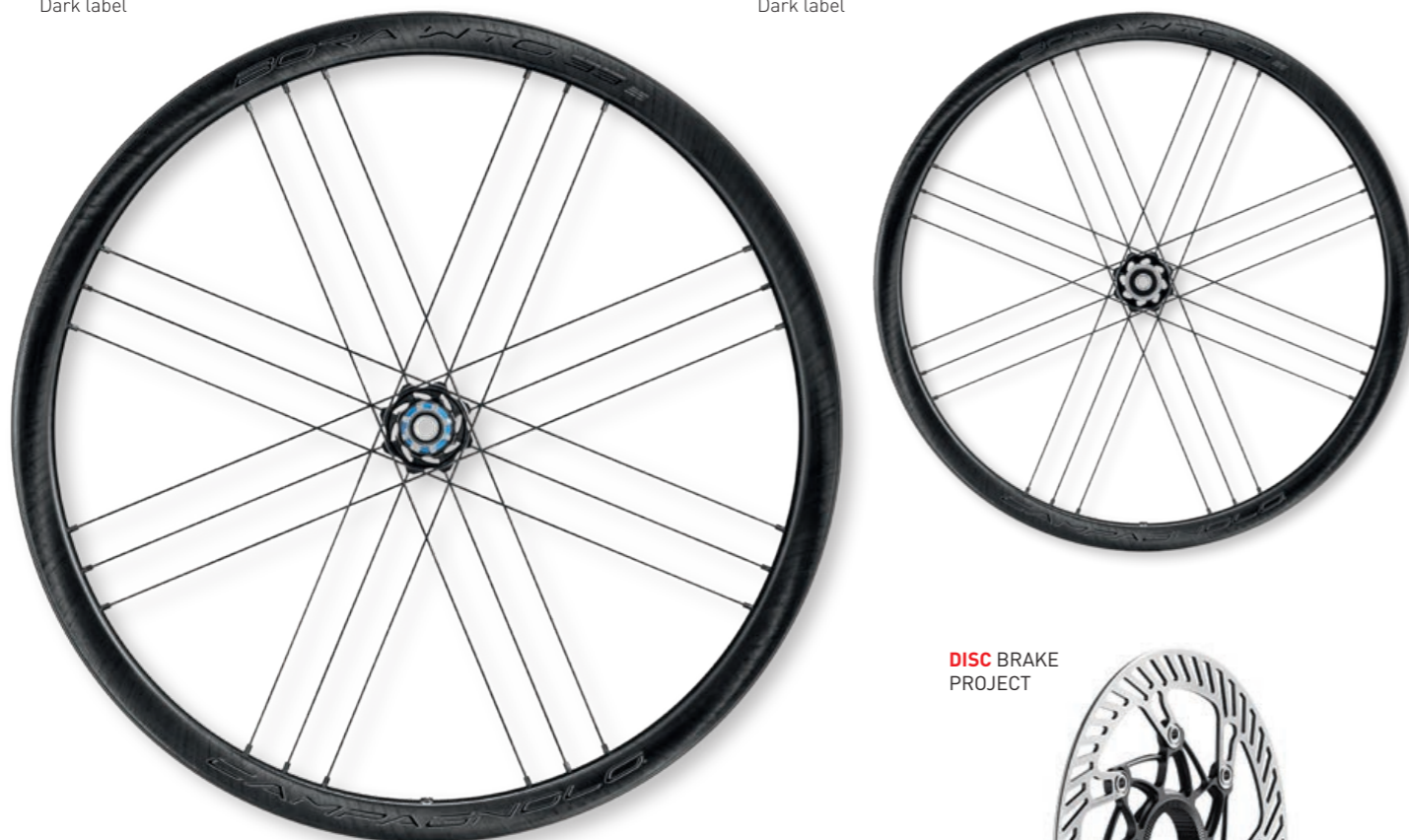

2-Way Fit™: 1450 g

DISC BRAKE
PROJECT

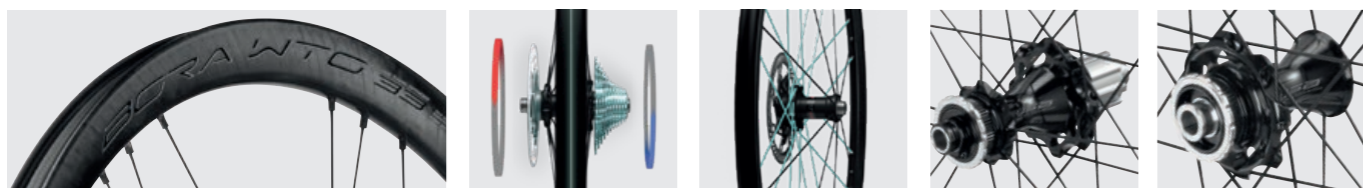

EXTREMELY AERODNAMIC FULL CARBON FIBER RIM, 26 mm WIDE, COMPATIBLE WITH BOTH TUBELESS AND CLINCHER TIRES:

Wind Tunnel Optimized to be extremely efficient. Campagnolo construction to ensure reactivity and reliability.

RDB™ RIM DYNAMIC BALANCE:

when manufacturing carbon rims, the carbon fibre is aligned in such a manner that the resulting rim is perfectly balanced.

100% HIGH MODULOUS CARBON FIBER:

the unique, hand made construction allows Campagnolo staff to orient each and every fiber in accordance to a specific design. Every single fiber, from the inner most layers to the unidirectional fiber used for the external application are of high modulus and oriented in a way to ensure professional level ride quality. Robust, reliable and reactive the Bora wheels are also lightweight. No paint or clear coat needed as the rim's anti UV resin leaves a naturally pristine finish.

WIND TUNNEL OPTIMIZED 3D SPOKE DESIGN: aerodynamic shape from all angles.

EXCLUSIVE G3™ SPOKE PATTERN:

perfect balance of spoke tension on both sides of the wheel. Reduces stress, increases transversal rigidity and the transmission of power to the wheel. G3™ eliminates vibrations even with "heavy" cyclists.

SELF-LOCKING NIPPLES:

it allows to maintain the right tension of the spokes and does not require any maintenance.



USB™ ULTRA SMOOTH BEARINGS:

top quality ceramic bearings create a perfectly smooth, resistance and maintenance free rolling.

ADJUSTING LOCKING WITH MICRO-SETTING:

for precision hub adjustment.

ALUMINIUM HUB SHELL:

permits an improved torque transfer across hub during the braking phase.

NEW FLANGE ROAD DESIGN:

allows integration with the AFS rotor on the braking force, transmission side.

AVAILABLE F/W BODIES:

Campagnolo - HG - XDR

The family of carbon aero wheels is further enhanced with the 33 mm profile. It delivers multiple benefits that can be noted on different routes, from the most demanding of sprints to relaunching after a bend, while still ensuring efficiency on the flat and now also suitable for the hardest uphill finishes! It's a truly multi-purpose wheel.

The 19 mm internal diameter of the rim enables tyres of 23mm, 25mm and 28mm to be fitted.

Safety is also guaranteed by the Campagnolo AC3 (All Conditions Carbon Control) technology, which ensures safe, modular braking in all weather conditions.

Available versions: bright and dark label, Campagnolo FW or HG11 body

REAR WHEEL
Bright label

FRONT WHEEL
Dark label



2-Way Fit™: 1388 g



EXTREMELY AERODNAMIC FULL CARBON FIBER RIM, 26.5mm WIDE, COMPATIBLE WITH BOTH TUBELESS AND CLINCHER TIRES:

Wind Tunnel Optimized to be extremely efficient. Campagnolo construction to ensure reactivity and reliability.

AC3™ (ALL CONDITIONS CARBON CONTROL) BRAKING SURFACE TECHNOLOGY:

improves the braking performances on dry and, above all, on wet conditions.

100% HIGH MODULOUS CARBON FIBER:

the unique, hand made construction allows Campagnolo staff to orient each and every fiber in accordance to a specific design. Every single fiber, from the inner most layers to the unidirectional fiber used for the external application are of high modulus and oriented in a way to ensure professional level ride quality. Robust, reliable and reactive the Bora wheels are also lightweight. No paint or clear coat needed as the rim's anti UV resin leaves a naturally pristine finish.

BRAKE PADS SPECIFIC FOR CARBON FIBER

WIND TUNNEL OPTIMIZED 3D SPOKE DESIGN: aerodynamic shape from all angles.

EXCLUSIVE G3™ SPOKE PATTERN:

perfect balance of spoke tension on both sides of the wheel. Reduces stress, increases transversal rigidity and the transmission of power to the wheel. G3™ eliminates vibrations even with "heavy" cyclists.

SELF-LOCKING NIPPLES:

it allows to maintain the right tension of the spokes and does not require any maintenance.



USB™ CERAMIC BALL BEARINGS:

reduces friction, provides greater smoothness, and maintains performance over time.

CUP AND CONE BEARINGS:

easy bearing adjustment.

ALUMINIUM HUB STRUCTURE, LIGHT AND EXTREMELY RIGID AND AERODYNAMIC:

optimised in the wind tunnel and designed for optimal rigidity and weight.

ALUMINIUM AXLE

reduces the weight of the wheel.

OVERSIZED FLANGE:

greater torsional stiffness and greater reactivity.



GRAVEL CARBON WHEELS

Campagnolo has always developed wheel systems at every level and for any sport with a single mantra: performance, style and maximum reliability.

Campagnolo gravel wheels, developed together with the revolutionary EKAR 13v transmission, are designed with the same mentality and with dedicated off-road solutions, whether this is a sprint along a compact "strada bianca" or portage during extreme bikepacking.

Campagnolo dedicated gravel wheels will take you anywhere!

LEVANTE™

Disc Brake

134

Levante™ is the first Campagnolo wheel specifically designed for gravel, incorporating all the features needed to deliver the maximum performance and elegance that are typical of Campagnolo wheels.

The 30mm profile carbon rim with 25mm internal channel and aluminium hub add up to a wheel that is light and easy to handle, stiff on the climbs and sure on the descents. Thanks to 2-Way Fit technology, Campagnolo guarantees complete compatibility with both clincher and tubeless tyres. The hole-free upper bridge, achieved through the patented MoMag system, allows a weight saving, increased rigidity and now also an aid to using tubeless tyres: no tape is required for the seal.

Levante™: Developed based on real-world experience to give you an outstanding riding experience.

REAR WHEEL

FRONT WHEEL



DISC BRAKE PROJECT



2-Way Fit™: 1485 g



H.U.L.C.

the Levante ultra-light carbon rims use the same H.U.L.C. hand-moulding process as our Bora Ultra WTO rims that dominate professional racing. This highly advanced production technique creates guaranteed defect-free rims, ensuring the maximum weight-to-strength ratio and an impeccable aesthetic finish right out of the mould.

MINI HOOK:

the 25 mm inner width of the Levante rim can accommodate a wide range of tyres from 38 mm up to 76 mm, ensuring maximum compatibility over all types of terrain. The shallow central channel makes the initial seating of the tubeless tyre on the 2-Way Fit rim quicker and easier during inflation.

2-WAY FIT:

the 2-Way Fit rim profile, with its specially designed mini-hook, also guarantees optimal compatibility with tubeless tyres, with tyre grip guaranteed at a variety of pressures.

LASERED GRAPHICS:

the lasered graphics on both the rim and the hubs have been designed to ensure the maximum durability of the wheel aesthetics in all usage conditions..

FRONT WHEEL SPOKES:

24 slim steel circular-section spokes at the front, in a two-cross pattern.

REAR WHEEL SPOKES:

24 slim steel circular-section spokes at the back, in a two-cross pattern.

CUP AND CONE BEARINGS:

easy bearing adjustment that reduces possible bearing play, maintaining performances over time and keeping the optimal contact angle between ball and track. USB and CULT update option (aftermarket kit).

BLACK ALUMINIUM MONOLITHIC HUB:

permits an improved torque transfer across hub during the braking phase.

CAMPAGNOLO N3W™ BODY:

the N3W™ body will be fitted by default on our new wheels, all equipped with a 36-tooth rack (diameter of ratchets: 33mm) to offer better resistance to torque.

AVAILABLE F/W BODIES:

Campagnolo N3W™ - HG - XDR





ENDURANCE CARBON WHEELS

Reliability and performance are our trademark. We were born on the most winding and disrupted paths and since then the road travelled has been long and exciting. Let our wheels show you the way. Forget your problems, put your trust in them. Enjoy the comfort, the explosivity and your well-deserved long hours in the saddle.

SHAMAL™ CARBON

Disc Brake

138

Shamal™ Carbon the first Campagnolo wheel dedicated to endurance, with a 21 mm internal channel that can accommodate larger tyres and ensure the cyclist maximum comfort on races and long rides. This new product was intended for a broader customer base, with a new, more accessible price point, but with every feature necessary to guarantee the maximum performance and style that characterise Campagnolo wheels.

Carbon rim with unidirectional finish and a differentiated front/rear profile, modern rounded profile, new aluminium hubs, cup-and-cone bearing system. Every design decision is determined by the sole goal of improving cyclists' performance over long hours on the saddle, providing comfort and rideability in all conditions.

REAR WHEEL

FRONT WHEEL



2-Way Fit™: 1585 g

DISC BRAKE PROJECT



FULL CARBON FIBER RIM, 21 mm INTERNAL CHANNEL, COMPATIBLE WITH BOTH TUBELESS AND CLINCHER TIRES:

the rim design allows the utmost versatility in tyre use, from the most comfortable for road use (25, 28, 30 mm) to the largest for cyclo-cross and gravel use (starting from 32 mm and going up to the largest, 45/50 mm).

DIFFERENTIATED PROFILE, FRONT 35 mm / REAR 40 mm:

the utmost comfort on longer rides, both in terms of bumps and ease of riding, without ever sacrificing performance.

100% HIGH MODULOUS CARBON FIBER:

the unique, hand made construction allows Campagnolo staff to orient each and every fiber in accordance to a specific design. Every single fiber, from the inner most layers to the unidirectional fiber used for the external application are of high modulus and oriented in a way to ensure professional level ride quality. No paint or clear coat needed as the rim's anti UV resin leaves a naturally pristine finish.

24 SPOKES IN STAINLESS STEEL WITH MEGA-G3™ SYSTEM:

ensures extremely good stiffness and reactivity, reinforcement on braking side at the front and cassette side at the rear.

FRONT WHEEL SPOKES:

16 slim steel circular-section spokes (left side - braking side)
8 slim steel circular-section spokes (right side).

REAR WHEEL SPOKES:

8 slim steel circular-section spokes (left side)
16 slim steel circular-section spokes (right side - cassette side).

NIPPLES:

black anodized self-locking nipples outside the rim allows for easy maintenance.

CUP AND CONE BEARINGS:

easy bearing adjustment that reduces possible bearing play, maintaining performances over time and keeping the optimal contact angle between ball and track. USB and CULT update option (aftermarket kit).

ALUMINIUM HUB SHELL:

permits an improved torque transfer across hub during the braking phase.

NEW CAMPAGNOLO N3W™ BODY:

the N3W™ body will be fitted by default on our new wheels, all equipped with a 36-tooth rack (diameter of ratchets: 33mm) to offer better resistance to torque.

AVAILABLE F/W BODIES:

Campagnolo N3W™ - HG - XDR





The SHAMAL™ ULTRA™ C17 represents the same fantastic performance that has made it THE go to aluminum race wheel for the better part of two decades while adding even more versatility and performance. The wider profile meets the C17 standard and is perfect for use with the increasingly popular 25/28mm tire sizes. This rim/tire interface proves to be more aerodynamic when compared to the same size tires mated to a C15 rim. The C17 also allows for a more surefooted grip in addition to increased comfort while increasing rigidity and thus reactivity at the same time thanks to its wider stance and optimized material usage.

REAR WHEEL

FRONT WHEEL



2-Way Fit™: 1475 g
Clincher: 1449 g



ALUMINIUM WHEELS

From the iconic, range-leading Shamal™ Ultra to the Calima™, the Campagnolo® range of aluminum wheels is without equal in the cycling marketplace. Incorporating advanced technologies and sophisticated performance solutions for both rim and disk brake specific uses alike makes for a range that offers the perfect solution for any cyclist.

Dynamic Balance™, G3™ spoke design, MoMag™ construction and a cornucopia of other technologies make the Campagnolo® aluminum wheelsets the obvious choice for the discerning cyclist looking for something more under his or her frame.

SHAMAL™ ULTRA	Rim Brake	141
ZONDA™	Rim Brake - Disc Brake	142 - 143
SCIROCCO™	Rim Brake - Disc Brake	144 - 145
CALIMA™	Rim Brake	146

TOROIDAL MILLING:
reduces the peripheral weight of the rim – makes the wheel extremely reactive.

DYNAMIC BALANCE™

2-WAY FIT™ PROFILE:
allows you to use either the classic clincher or the innovative tubeless tire.

ULTRA-FIT™:
easy tire mounting – maximum safety – less friction – less energy dispersion – improved performance.

MOMAG™:
allows the external profile of the rim to be free of holes.

DIFFERENTIATED RIM HEIGHT
FRONT (24 - 27 mm) AND REAR (27 - 30 mm)

SPOKES ANTI-ROTATION SYSTEM™:
keeps the spokes in the position of maximum aerodynamic penetration.

SELF-LOCKING NIPPLES:
allow the ideal spoke tension to be maintained at length, eliminating friction on the rim. All this translates into constant high performance throughout the life of the product.

EXCLUSIVE MEGA-G3™ SPOKE PATTERN:
perfect balance of spoke tension on both sides of the wheel. Reduces stress, increases transversal rigidity and the transmission of power to the wheel. Mega-G3™ eliminates vibrations even with "heavy" cyclists.

AERO SPOKES IN ALUMINIUM:
maximum aerodynamic penetration - lower weight and greater reactivity.



USB™ CERAMIC BALL BEARINGS:
reduces friction, provides greater smoothness, and maintains performance over time.

CARBON FIBRE HUB BODY:
high degree of lateral stiffness – reduces the weight to the minimum.

ALUMINIUM AXLE
low weight, high stiffness.

OVERSIZED FLANGE:
increases the torsional stiffness, increasing reactivity at each change of pace of the cyclist.

DIFFERENTIATED HUB DIAMETER FRONT AND REAR:
optimized for structural integrity and performance. Small front hub aids in aerodynamic efficiency.

The very first Campagnolo® branded wheelset developed specifically for disc brake equipped road bikes comes at a time where the market has plenty of solutions for road disc wheelsets but lacks many solutions that offer a level of performance, reliability, safety and integrity that has been associated with Campagnolo® wheels for traditional rim brakes. The Zonda™ disk brake wheelset is not only more reactive when compared to the rim brake version but it is also 25 grams lighter than its closest competitor. Adding more tech and more componentry to a wheel while increasing its performance, lowering its weight and ensuring that same Campagnolo® reliability cyclists have come to expect make a wheelset that should be at the top of any disc brake riding athlete in the market for a serious upgrade. It is available with QR and HH12 with 135 and 142 OLD.

REAR WHEEL

FRONT WHEEL



DISC BRAKE PROJECT

Clincher: 1675 g

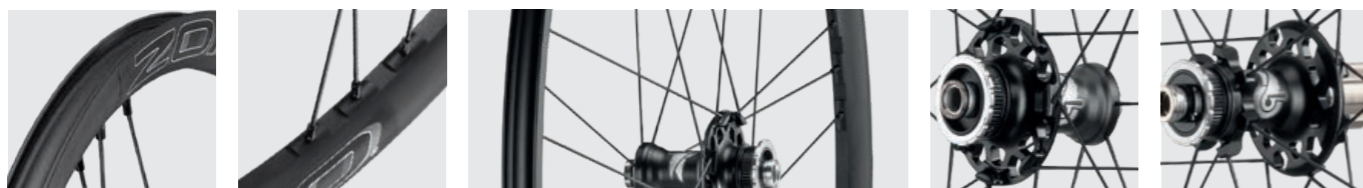

NEW ASYMMETRIC RIMS PROFILE (26 – 28 mm)

MILLED RIM:
this machining makes possible to reduce the peripheral weight of the rim and makes the wheel extremely reactive.

RDB™ - RIM DYNAMIC BALANCE:
the concept is simple and elegant: balance the weight of the gasket, with an item of similar weight placed on the exact opposite side.

MOMAG™:
allows the external profile of the rim to be free of holes to benefit of both stiffness and weight.

SPOKES:
G3™ technology applied also to the front wheel to better perform at high braking power.

FRONT WHEEL SPOKES:
14 spokes in stainless steel section diameter 2/1,6/2 mm (left side - braking side)
7 spokes in stainless steel section diameter 2/1,6/2 mm (right side).

REAR WHEEL SPOKES:
7 spokes in stainless steel section diameter 2/1,6/2 mm (left side)
14 spokes in stainless steel section diameter 2/1,6/2 mm (right side - cassette side).

NIPPLES:
black anodized self-locking nipples outside the rim allows for easy maintenance.

CUP AND CONE BEARINGS:
easy bearing adjustment that reduces possible bearing play, maintaining performances over time and keeping the optimal contact angle between ball and track.

ADJUSTING LOCKING WITH MICRO-SETTING TECH:
for an accurate adjustment of the hub that prevents the creation of any play.

21 SPOKES IN STAINLESS STEEL WITH MEGA-G3™ SYSTEM:
ensures extremely good stiffness and reactivity, reinforcement on braking side at the front and cassette side at the rear. It gives a very race design to the wheelset.

The universally lauded Zonda™ get an update for 2017 range and the best-selling Campagnolo® wheelset incorporated a C17 class rim. The highly respected Zonda™ with its new 22,5 mm wide rim accepts larger clincher tires making for increased performance, comfort and a more efficient tire/rim interface. A new rim coupled with the same technologies that put the Zonda™ in a league apart from the rest of the wheels in its segment make this wheelset one that punches far above its weight. And while speaking of weight, the Zonda™ offers this added performance and wider profile while reducing its overall weight more than 10 grams.

REAR WHEEL

FRONT WHEEL



Clincher: 1540 g



MOMAG™:
allows the external profile of the rim to be free of holes – increases structural resistance – makes rim tape unnecessary and reduces the weight of the wheel.

MILLED RIM
DIFFERENTIATED RIM HEIGHT FRONT (24 - 27 mm) AND REAR (27 - 30 mm)

DYNAMIC BALANCE™

SPOKES ANTI-ROTATION SYSTEM
keeps the spokes in the position of maximum aerodynamic penetration.

EXCLUSIVE MEGA-G3™ SPOKE PATTERN:
perfect balance of spoke tension on both sides of the wheel. Reduces stress, increases transversal rigidity and the transmission of power to the wheel. Mega-G3™ eliminates vibrations even with "heavy" cyclists.

SPOKES WITH AERODYNAMIC PROFILE:
Front: 16 spoke variable profile Aero radials in stainless steel.
Rear: 21 spoke variable profile Aero in stainless steel with doubling on the cassette side.

SELF-LOCKING NIPPLES:
allow the ideal spoke tension to be maintained at length, eliminating friction on the rim. All this translates into constant high performance throughout the life of the product.

REAR HUB WITH MEGA-G3™ OVERSIZED FLANGE:
increases the torsional stiffness, increasing reactivity at each change of pace of the cyclist.

ALUMINIUM HUB BODY:
provides a high degree of lateral stiffness.

ALUMINIUM AXLE:
low weight, high stiffness.

DIFFERENTIATED HUB DIAMETER FRONT AND REAR:
optimized for structural integrity and performance. Small front hub aids in aerodynamic efficiency.

NEW ADJUSTING LOCK RING WITH MICRO-SETTING:
for an accurate adjustment of the hub that prevents the creation of play.

33 mm is the entry point for the mid-profile rim segment. This is when we start to talk about aerodynamics, stability at high speeds and absolute steering precision. The Scirocco™ Disc Brake is a sturdy, precise aluminium wheel with sophisticated solutions, like straight-head spokes and the 2-Way Fit™ Ready profile, assembled in a highly competitive race-ready package. This wheel has character and can quite easily take on the role of the cyclist's only wheel or the perfect training partner, offering an aerodynamic advantage and effortless rideability. It is ideal for aerodynamic race bikes and it responds perfectly to the needs of both triathletes and roulers who looking to perform well on climbs. Every watt will enhance performance, every turn will be carried out with precision. Additionally, the very comfortable features of the 19mm internal width will shine in the Endurance segment.

REAR WHEEL

FRONT WHEEL



DISC BRAKE PROJECT

2-Way Fit™ Ready: 1739 g



33 mm RIM HEIGHT:
extremely versatile rim profile. High enough for added aerodynamic efficiency that remains stable even in crosswinds. Low enough to ensure lightweight construction.

2-WAY FIT READY PROFILE WITH 19 mm INNER WIDTH:
ensures compatibility with the larger tire widths and unique design facilitates assembly. Allows use of either clincher or tubeless ready tyres according to the indications on the page related to the "2-Way Fit Ready" technology.

NIPPLE SUPPORT TAB INSIDE THE RIM:
unique solution reduces weight in addition to optimizing the distribution of tension to ensure a longer wheel lifetime.

WELDED RIM:
increase in lateral rigidity.

SPOKES:
G3™ technology applied also to the front wheel to better perform at high braking power.

FRONT WHEEL SPOKES:
14 spokes in stainless steel (left side - braking side)
7 spokes in stainless steel (right side).

REAR WHEEL SPOKES:
7 spokes in stainless steel (left side - braking side)
14 spokes in stainless steel (right side - cassette side).

NIPPLES:
black anodized self-locking nipples outside the rim allows for easy maintenance.

MEGA-G3 OVERSIZE FLANGE ON THE REAR WHEEL (FW BODY SIDE):
increases the torsional rigidity, increased reactivity.

MEGA-G3 OVERSIZE FLANGE ON THE FRONT WHEEL (DISC SIDE):
increases torsional rigidity and ensures greater rideability.

ALUMINIUM AXLE:
confers lightweight construction to wheel.

ADJUSTING LOCKING WITH MICRO-SETTING TECH:
for an accurate adjustment of the hub that prevents the creation of any play.

With the easily recognizable 35mm profile height, the Scirocco™ is a versatile wheelset solution that offers strengths in every field. From aerodynamics and handling, weight and stiffness. It is predictable, reactive and light. The Scirocco™ is an all round wheelset aimed at passionate cyclists and professionals alike. The 35 mm profile is perhaps the perfect wheel to take on any challenge that the road or race presents.

REAR WHEEL

FRONT WHEEL



Clincher: 1755 g



35 mm AERODYNAMIC PROFILE IN A MID-END ALUMINIUM RIM:
aerodynamics in a mid-end aluminum rim. Advanced aero efficiency while being extremely easy to handle even in cross winds.

DYNAMIC BALANCE™:
every point of the rim is counter-balanced by an equal weight on the opposite side. Maximum stability of the wheel even at high speeds.

WELDED RIM:
to increase stiffness and braking surface precision allowing a smoother progressive braking.

AERODYNAMIC PROFILE:
radial spokes in stainless steel. 16 spoke radial configuration on the front wheel, 21 spokes with double spoke pattern on the cassette side.

EXCLUSIVE MEGA-G3™ SPOKE PATTERN:
the Mega-G3™ creates a perfect spoke tension balance on both sides of the wheel. This helps to reduce spoke stress, increases transversal rigidity and as a consequence improved power to wheel transmission.

ALUMINIUM HUB AND AXLE:
saves weight and increases lateral stiffness.

MEGA-G3™ OVERSIZE FLANGE ON THE REAR WHEEL (CASSETTE SIDE):
this is used to increase torsional stiffness, creating greater reactivity with each change in the pace.

HI-END FREE HUB BODY:
the Scirocco™ hubs uses the same construction components normally reserved for high end hubs. Available in two options: Campagnolo (aluminum) and HG11 (in aluminum with the Plasma Electrolytic Oxidation treatment) low weight, high stiffness.

A wheel that is requested by passionate cycle lovers to seasoned professionals alike. Light enough to tackle the steepest of climbs yet strong and flexible enough to affront the roughest of roads. The Calima™ wheelset offers to all cyclists the possibility to experience the renowned quality and technology of Campagnolo®.

REAR WHEEL

FRONT WHEEL



Clincher: 1826 g



24mm PROFILE:
a 24mm symmetrical low profile rim that creates a front wheel that is precise in directional changes and a rear wheel that is reactive to power transfer and changes in pace.

C17 CLASS FOR CLINCHER TYRES:
to permit the fitting of a wider tyre (25 mm minimum) allowing for easier tyre fitting.

GLUED RIM:
glued rim for increased precision on the braking surface allowing smoother progressive braking.

MACHINED PRECISE SPOKE SEAT:
permitting a longer spoke life.

ED (ELECTRODEPOSITION) BLACK SPOKES:
Front: 18 radial spokes in steel
Rear: 27 spokes in steel with double spoke count on the cassette side.

EXCLUSIVE G3™ SPOKE PATTERN:
creating a perfect balance of the spoke tension on both sides of the wheel. Reduces stress, increases transversal rigidity and the transmission of power to the wheel.

ALUMINUM HUBS:
for increased lateral stiffness.

G3™ FLANGE ON THE REAR WHEEL:
to increase torsional stiffness and greater reactivity with each change of pace.

STEEL AXLE:
increases wheel stiffness permitting a wheel geometry that allows the use of different free hub bodies. Hi-end free hub body using the same construction components normally reserved for high end hubs. Available in two options: Campagnolo (aluminum) and HG11 (steel).





TRIATHLON TIME TRIAL

Running against time and winning.

When the margin of victory is measured in millimeters or milliseconds the smallest things count and perfection is the ultimate goal. To give you all of this Campagnolo® has designed and developed, in collaboration with the best Triathlon and Time Trial athletes, the range dedicated to these disciplines. With new technology such as bar-end brake levers that allow you to change gears you can see that Campagnolo® is making sure that technical advantages are within your grasp in your quest for victory atop your triathlon or TT bike. The starting gun has sounded. With Campagnolo® Triathlon/TT equipment you will reach the finish line faster and fresher than you ever imagined.



SUPER RECORD™ EPS™ CONTROLS

Triathlon and Time Trial cyclists, just like any other athlete, must have perfect control, regardless of the position they assume. The Bar-End Super Record™ EPS™ controls and Super Record™ EPS™ brake levers allow the cyclist to shift no matter the position of his or her hands.

The Super Record™ EPS™ TT controls have been designed not only to offer easy access, but also to enable the cyclist to maintain the best posture from an aerodynamic point of view while still maintaining maximum control. In other words, a simple click in any position brings you closer to victory with Campagnolo®.



SUPER RECORD™ EPS™
98 g/Pair, cables included



SUPER RECORD™ EPS™
110 g/Pair, cables included

NEW EPS™ DB CONTROLS

Aerodynamic and, above all, ergonomic, the EPS™ disc brake controls enable shifting in any riding position. The hydraulic system has been perfectly integrated in the shape of the controls: this ensures unbeatable aerodynamics and makes it possible to have Campagnolo high-performance braking also on time trial bikes with disc brakes.



448 g (per set of two, controls with buttons and

V4 DTI™ EPS™ BAR-END INTERFACE

Designed for Triathlon and Time Trial bicycles, the EPS™ interface has two separate cable inputs for use both with Bar End levers and brake lever controls. This ultra-light component may be installed on either the brake cables or the handlebar mount. Super Record™ EPS™ 12x2 Speed groupset uses the V4 interface.



45 g, cables included

EPS™ BAR-END CONTROLS

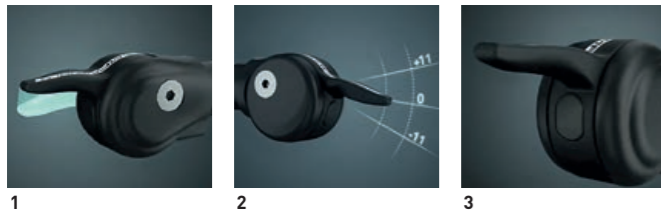

1. BACK-TO-ZERO POSITION:
allows the lever to return always to its initial position. Reduces effort required to shift and maintains the lever in the most aerodynamic position.

MULTI-DOME TECH™:
the 5-dome technology perfected by Campy Tech Lab™ together with Campagnolo athletes has made it possible to strike the perfect balance between operating force and tactile shift feedback. It also eliminates the possibility of unintentionally shifting the rear or front derailleur.

2. MULTI-SHIFTING SYSTEM™:
lets the rider shift up or down by up to 11 sprockets in a single action

3. MODE BUTTON:
the "Mode" buttons allow the user to check battery charge, make fine adjustments to the rear or front derailleur - even in the middle of a race (with the "ride setting" procedure), and set the zero position of the rear and front derailleur ("zero setting" procedure).

100% WATER-PROOF:
all control components are built to operate in any weather conditions in compliance with the IP67 standard.

EPS™ BRAKE CONTROLS



1. AERODYNAMIC PROFILE:
maximum aerodynamic coefficient.

2. QUICK-RELEASE SYSTEM:
it makes it easier to install and remove the wheel and allows, even during the race, to open the distance between the rim and the brake pads.

3. ERGONOMIC PROFILE FOR THE LEVERS:
maximum safety and adjustable braking system.
- Carbon fibre (Record™ EPS™)

DISTANCED BUTTONS FOR SPROCKET UP- AND DOWNSHIFT AND CHAINRINGS:
each button has its own function. This ensures precise control and eliminates the possibility of errors whatever the conditions (winter temperatures, rough terrain, winter gloves).

EPS™ DB CONTROLS



1. AERODYNAMIC PROFILE:
maximum aerodynamic coefficient.

2. ERGONOMIC LEVER PROFILE:
maximum safety and modular braking.

EASY MAINTENANCE:
a single wrench is all that's needed to fit and remove the controls; no need to remove the controls to drain the hydraulic system and the valve is easy to reach.

3. DISTANCED BUTTONS FOR SPROCKET UP- AND DOWNSHIFT AND CHAINRINGS:
each button has its own function. This ensures precise control and eliminates the possibility of errors whatever the conditions (winter temperatures, rough terrain, winter gloves).

DTI™ EPS™ V3 INTERFACE



1. DIALOGUE WITH "MYCAMPY" APP:
Wireless system to communicate with "MyCampy" App by PC / Notebook / Tablet / Smartphone (BTLE), which allows the EPS groupset holder to personalize its own settings.

2. EASY ACCESS TO THE CHARGING PORT:
recharging port positioned on the upper part and covered by a rubber cover linked to the interface.

"ZERO SETTING" AND "RIDE SETTING":
used to set the initial configuration of the components and make fine adjustments during a race.

3. RGB LED:
visualises battery charge status.
The unit also checks for system faults, warning the user when necessary via an RGB LED.

TWO POSSIBLE INTERFACE MOUNTING OPTIONS:
the unique design of the interface lets the user choose whether to install it on the brake cable or on the handlebar mount..

The Bora™ Ultra™ TT has always accompanied the greatest chrono men in cycling in their attempts to win international time trial medals. In 2022, the Campagnolo road lenticular wheel has been further innovated, maintaining its main characteristics of lightness and stiffness even in the new configuration for disc brakes. Its notes and extraordinary performance have now been adapted and implemented to fit any top-end bike with the highest expression of Campagnolo technology. The Bora™ Ultra™ WTO TT DB will accompany you in time trials, helping you gain a valuable advantage with every pedal stroke.

RIGHT SIDE

LEFT SIDE



2-Way Fit™: 1050 g
Tubular: 864 g

DISC BRAKE PROJECT



DEVELOPED ENTIRELY TO FIT DISC BRAKES AND MAINTAIN THE HIGH LEVELS OF STIFFNESS that have always distinguished all Campagnolo lenticular wheels.

ENTIRELY IN HIGH MODULUS CARBON: the rim in unidirectional carbon guarantees typical Campagnolo rideability.

IT DOES AWAY WITH ANY FLECTION EFFECTS, ESPECIALLY CLOSE TO THE BOTTOM BRACKET

THE 19 MM BED ALLOWS FOR BETTER AIR PENETRATION AT HIGH SPEEDS

ITS INNOVATIVE DESIGN AIMS TO REDUCE PROFILE DIMENSIONS TO A MINIMUM

IT GUARANTEES CONSIDERABLY IMPROVED AERODYNAMICS FOR THE BIKE AS A WHOLE

GRAPHICS FEATURING THE "WINGED WHEEL": the legendary Campagnolo® "Winged Wheel" logo identifies Campagnolo® lenticular wheels that use the very latest carbon fiber technologies.



BEARINGS WITH CULT™ TECHNOLOGY: the combination between the highest quality ceramic bearings and housing in special steel. CULT™ bearings have a friction coefficient 40% lower than standard sealed bearings, and in tests, can spin for 5 ½ times longer.

CUP AND CONE BEARINGS: easy bearing adjustment – reduces the possibility bearing play – precision operation – maintains performance over time.

LIGHTWEIGHT AND EXTREMELY RIGID ALUMINUM HUB CONSTRUCTION

CASSETTE: compatibile with Campagnolo® 10, 11 and 12 speed cassettes as well as Shimano Inc. 9, 10, and 11 speed cassettes.

CORPETTI R/L DISPONIBILI: Campagnolo N3W™ - HG - XDR

SUGGESTED WHEELS

BORA™ ULTRA TT Rim Brake



BORA™ ULTRA WTO 80 Disc Brake



BORA™ ULTRA WTO 60 Disc Brake



BORA™ WTO 77 Front Rim Brake



BORA™ WTO 60 Disc Brake / Rim Brake



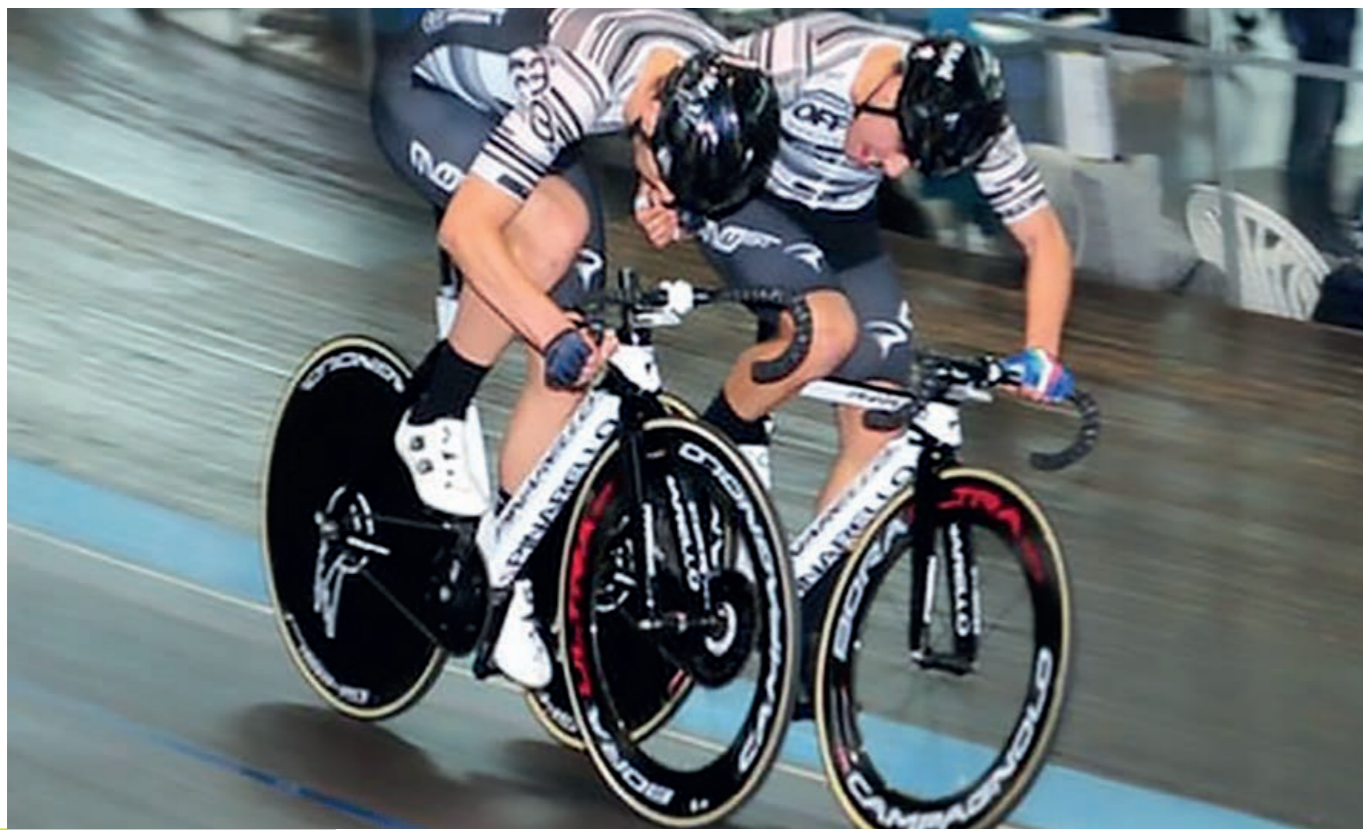

PISTA

From the starting gun a track racer exerts an extreme amount of force and the physical test increases exponentially as the race continues. No matter what the event, the track athlete is obligated to run a perfect race. Nowhere to hide. No place for even the slightest error. Track racing demands an incredible amount of expertise and extreme attention to detail in order for an athlete to be successful. It is with this same spirit that Campagnolo® develops its products; attention to detail, search for perfection and desire to continuously improve.



© Lotto Soudal-Facepeeters

Campagnolo® is quite proud of its glorious track record with the Ghibli™ disc wheel, the very first tenso-structure wheel ever introduced in the cycling world. Despite the fact that the Ghibli™ was still very competitive with newer models, the R&D department at Campagnolo® sought to take lessons from this iconic wheel and build upon them in order to produce the next generation of extreme performance. Incorporation of carbon fiber throughout in addition to completely new construction techniques give the new wheelset an ultralight build while not sacrificing its performance attributes.

FRONT WHEEL

REAR WHEEL



Tubular: 1625 g (pair)

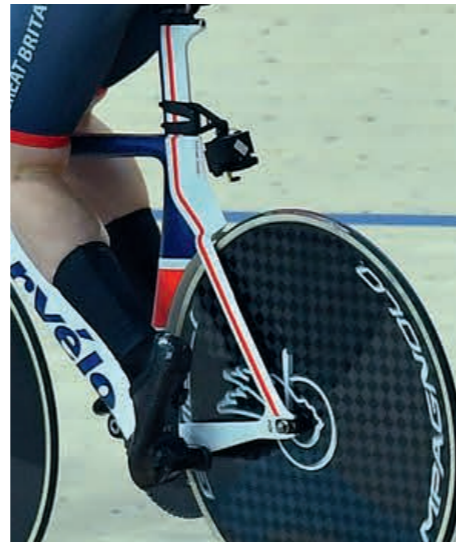

Minimizing material but maximizing efficiency in its employment allowed the Campy Tech Lab™ to not only make this new wheel lighter but, more importantly for its specific intended purpose of battling the clock, to improve its reactivity and rigidity. The new structure and design allows for solid and stable stance that transfers power towards forward motion as opposed to allowing lateral flex or torsion.

The new structure, despite its lightweight construction, is also the stiffest amongst the leading disc wheel competitors according to laboratory tests.

With a front wheel tipping the scales at a scant 800 grams and the rear at an incredibly low 825 grams the Ghibli™ wheels are effectively the lightest performance solution available.



BEARINGS WITH CULT™ TECHNOLOGY:

the combination between the highest quality ceramic bearings and housing in special steel. CULT™ bearings have a friction coefficient 40% lower than standard sealed bearings, and in tests, can spin for 5 ½ times longer.

Available with standard track nuts and with 12mm thru axle at the front, in two versions with 100mm or 65mm O.L.D.

This new wheelset was proven not only via strenuous lab testing and countless hours under athletes in training, but also in competition.

In its first official competition the Ghibli™ and its new ultra-performance construction were able to confer to **Alex Dowsett** a technological advantage that played a fundamental role in breaking the Hour Record.

A few months later, the Ghibli™ was the star of the 4 km individual pursuit thanks to **Filippo Ganna**, the nineteen-year-old world champion aided tremendously in his quest for victory by his ultra-performance Campagnolo® wheels.

The remarkable performance advantage represented by the Ghibli™ did not go unnoticed, so much so that the **Canadian and British national teams** will use them in their attempts to win Olympic medals for the team pursuit in Rio de Janeiro.

The Bora™ Ultra™ 80 track version matches perfectly to the Ghibli™ disc wheel to make an extremely competitive and race-winning combination. The two wheels work well together for all of the track disciplines involving group activity such as the points race, Madison, Elimination and Scratch thanks to the extreme lightweight of both the disc wheel (perhaps the lightest available) as well as the Bora™ Ultra™ 80's 705 grams. This spoked wheel allows for extreme agility, continuous relaunches and quick changes of direction... making it an excellent choice for certain disciplines on the track. The Bora™ Ultra™ 80 track version brings Bora™ performance to the track and with it, Campagnolo® results. Previously well known for climbing mountains and crushing time trials on the road, the Pista version of the Bora™ will be sure to climb podiums and crush records on the wooden boards of the track.



Tubular: 705 g (front)

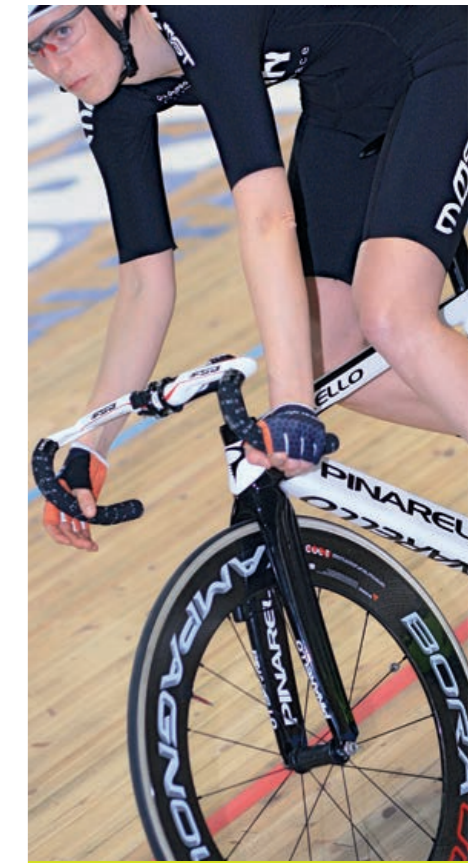

FULL CARBON HIGH PROFILE FOR 80mm TUBULAR: provides the maximum aerodynamic penetration. Extremely high lateral wheel stiffness and reactivity.

EXCLUSIVE PRESSING SYSTEM FOR THE RIM IN UNPAINTED CARBON: elegant polished finish is result of advanced and patented production technique. Eliminating need for paint keeps weight lower..

RDB™ RIM DYNAMIC BALANCE

SPOKES WITH AERODYNAMIC PROFILE: provides the maximum aerodynamic penetration. Reduces aerodynamic drag saving rider energy.

SELF-LOCKING ALUMINIUM NIPPLES



BEARINGS WITH CULT™ TECHNOLOGY: the combination between the highest quality ceramic bearings and housing in special steel. CULT™ bearings have a friction coefficient 40% lower than standard sealed bearings, and in tests, can spin for 5 ½ times longer.

CARBON FIBRE HUB: provides a high degree of lateral stiffness and reduces weight to the minimum.

CUP AND CONE BEARINGS

ALUMINIUM AXLE



TECH DATA

Over the course of the previous pages in this catalog you can find a great deal of general information regarding every Campagnolo® product. However, if you need more specific information and technical data we have compiled an even greater resource in the following section.

Should you need yet more information please visit: www.campagnolo.com

Please note that we reserve the right to change products, surface finish and specifications at any moment without prior notice.

GROUPSETS	158
TRIATHLON / TIME-TRIAL	169
WHEELS	170
SERVICE CENTER - SALES NETWORK	178

GRAVEL GROUPSETS



COMPONENT	OPTIONS	WEIGHT [g]	WEIGHT REFERENCE
EKAR™ rear derailleur	-	275	standard hanger version
EKAR™ Ergopower™ DB controls	-	420	Pair
EKAR™ crankset	165 mm, 170 mm, 172,5 mm, 175 mm 38, 40, 42, 44	615	172,5 mm, 38
PRO-TECH™ threaded cups	ITA: 70x (36x24 tpi) BSA: 68x (1,37"x24 tpi)	50	BSA
PRO-TECH™ press-fit cups	BB30: (68x42) mm BB86: (86,5x41) mm PF30: (68x46) mm BB386: (86,5x46) mm BB RIGHT: (79x46) mm BB30A: (73x42) mm T47x68 T47x86	50	BB86
EKAR™ sprockets	9-36 (9-10-11-12-13-14-16-18-20-23-27-31-36) 9-42 (9-10-11-12-13-14-16-18-21-25-30-36-42) 10-44 (10-11-12-13-14-15-17-20-23-27-32-38-44)	340	9-36
EKAR™ chain	117 links / C-Link 118 links / Classic Pin	242	117 links
EKAR™ caliper	140 mm	95	140 mm Rear (1 piece - pads included)
EKAR™ rotor	160 mm 140 mm	123	140 mm (1 piece)
COMPLETE GROUPSET		2.385	2 calipers 2 rotors

EXTRA COMPONENTS	OPTIONS	CATEGORY
Rear Caliper Bolts	for 10-14 mm rear mount for 15-19 mm rear mount for 20-24 mm rear mount for 25-29 mm rear mount for 30-34 mm rear mount for 35-39 mm rear mount	Disc Brake (MANDATORY)
Oil	50 ml	Disc Brake
Bleeding Kit	-	Disc Brake
140 mm to 160 mm Rear Caliper adapter	-	Disc Brake
EKAR™ Bottle cage	-	General
EKAR™ Bottle	550 ml	General

ROAD GROUPSETS

SUPER RECORD™ EPS™
12x2 SPEED™

DISC BRAKE

COMPONENT	OPTIONS	WEIGHT [g]	WEIGHT REFERENCE
SUPER RECORD™ EPS™ rear derailleur	compatible with sprocket sets 11-29, 11-32	234	cables included
SUPER RECORD™ EPS™ Ergopower™ DB controls	-	381	Pair (cables included)
SUPER RECORD™ EPS™ front derailleur	-	132	cables included
DTI™ EPS™ V4 Power Unit	-	135	cables included
DTI™ EPS™ V4 External Interface	-	33	cables included
DTI™ EPS™ V4 Internal Interface	-	11	cables excluded
SUPER RECORD™ crankset	165 mm, 170 mm, 172,5 mm, 175 mm 39-53 - 36-52 - 34-50	618	172,5 mm, 34-50 (2 bearings assembled)
SUPER RECORD™ ULTRA-TORQUE™ threaded cups	ITA: 70x (36x24 tpi) BSA: 68x (1,37"x24 tpi)	43	BSA
ULTRA-TORQUE™ press-fit cups	BB30: (68x42) mm, BB86: (86,5x41) mm, PF30: (68x46) mm, BB386: (86,5x46) mm, BB RIGHT: (79x46) mm, BB30A: (73x42) mm	40	BB86
SUPER RECORD™ sprockets	11-29 11-32	266	11-29
SUPER RECORD™ chain	-	220	110 links
CAMPAGNOLO® caliper	160 mm Front 160 mm Rear 140 mm Rear	118	140 mm Rear (1 piece - pads included)
CAMPAGNOLO® rotor	160 mm 140 mm	99	140 mm (1 piece)
COMPLETE GROUPSET		2.497	2 calipers 2 rotors

EXTRA COMPONENTS	OPTIONS	CATEGORY
EPS™ V4 Power Unit Holder	for bottle cage for ø 27 mm seatpost for ø 32 mm seatpost	EPS™ V4
EPS™ Battery Charger	-	EPS™
EPS™ Power Cable	AUS CEE UK US	EPS™
RECORD™ EPS™ extension cable kit	-	EPS™ SUPER RECORD™/RECORD™
Rear Caliper Bolts	for 10-14 mm rear mount for 15-19 mm rear mount for 20-24 mm rear mount for 25-29 mm rear mount for 30-34 mm rear mount for 35-39 mm rear mount	Disc Brake (MANDATORY)
Oil	100 ml, 250 ml, 1.000 ml	Disc Brake
Bleeding Kit	-	Disc Brake
140 mm to 160 mm Rear Caliper adapter	-	Disc Brake
Chain Guard	for braze-on for ø 32/35 clamp	Accessory
Front Derailleur Clamp	ø 32 mm - ø 35 mm	Accessory
Front Derailleur Stiffness Increaser	-	Accessory
RECORD™ Headset	-	General
RECORD™ front hub	-	General
RECORD™ rear hub	-	General

TECH DATA

SUPER RECORD™ EPS™
12x2 SPEED™

RIM BRAKE

COMPONENT	OPTIONS	WEIGHT [g]	WEIGHT REFERENCE
SUPER RECORD™ EPS™ rear derailleur	compatible with sprocket sets 11-29, 11-32	234	cables included
SUPER RECORD™ EPS™ Ergopower™ controls	-	280	Pair (cables included)
SUPER RECORD™ EPS™ front derailleur	-	132	cables included
DTI™ EPS™ V4 Power Unit	-	135	cables included
DTI™ EPS™ V4 External Interface	-	33	cables included
DTI™ EPS™ V4 Internal Interface	-	11	cables excluded
SUPER RECORD™ crankset	165 mm, 170 mm, 172,5 mm, 175 mm 39-53 - 36-52 - 34-50	618	172,5 mm, 34-50 (2 bearings assembled)
SUPER RECORD™ ULTRA-TORQUE™ threaded cups	ITA: 70x (36x24 tpi) BSA: 68x (1,37"x24 tpi)	43	BSA
ULTRA-TORQUE™ press-fit cups	BB30: (68x42) mm, BB86: (86,5x41) mm, PF30: (68x46) mm, BB386: (86,5x46) mm, BB RIGHT: (79x46) mm, BB30A: (73x42) mm	40	BB86
SUPER RECORD™ sprockets	11-29 11-32	266	11-29
SUPER RECORD™ chain	-	220	110 links
SUPER RECORD™ brakes	-	311	Pair
CAMPAGNOLO® direct mount brake	Front Rear Seat Stay	168	1 piece
COMPLETE GROUPSET		2.247	-

EXTRA COMPONENTS	OPTIONS	CATEGORY
EPS™ V4 Power Unit Holder	for bottle cage for ø 27 mm seatpost for ø 32 mm seatpost	EPS™ V4
EPS™ Battery Charger	-	EPS™
EPS™ Power Cable	AUS CEE UK US	EPS™
RECORD™ EPS™ extension cable kit	-	EPS™ SUPER RECORD™/RECORD™
RECORD™ direct mount brake	Rear Under BB	Brakes
Chain Guard	for braze-on for ø 32/35 clamp	Accessory
Front Derailleur Clamp	ø 32 mm ø 35 mm	Accessory
Front Derailleur Stiffness Increaser	-	Accessory
RECORD™ Headset	-	General
RECORD™ front hub	-	General
RECORD™ rear hub	-	General

GROUPSETS

SUPER RECORD™
12x2 SPEED™

DISC BRAKE

COMPONENT	OPTIONS	WEIGHT [g]	WEIGHT REFERENCE
SUPER RECORD™ rear derailleur	compatible with sprocket sets 11-29, 11-32, 11-34	181	standard hanger version
SUPER RECORD™ Ergopower™ DB controls	-	462	Pair
SUPER RECORD™ front derailleur	-	79	-
SUPER RECORD™ crankset	165 mm 170 mm 172,5 mm 175 mm 39-53 36-52 34-50	618	172,5 mm, 34-50 (2 bearings assembled)
SUPER RECORD™ ULTRA-TORQUE™ threaded cups	ITA: 70x (36x24 tpi) BSA: 68x (1,37"x24 tpi)	43	BSA
ULTRA-TORQUE™ press-fit cups	BB30: (68x42) mm BB86: (86,5x41) mm PF30: (68x46) mm BB386: (86,5x46) mm BB RIGHT: (79x46) mm BB30A: (73x42) mm	40	BB86
SUPER RECORD™ sprockets	11-29 11-32 11-34	266	11-29
SUPER RECORD™ chain	-	220	110 links
CAMPAGNOLO® caliper	160 mm Front 160 mm Rear 140 mm	118	140 mm (1 piece - pads included)
CAMPAGNOLO® 03 rotor	160 mm 140 mm	99	140 mm (1 piece)
COMPLETE GROUPSET		2.326	2 calipers 2 rotors

EXTRA COMPONENTS	OPTIONS	CATEGORY
Rear Caliper Bolts	for 10-14 mm rear mount for 15-19 mm rear mount for 20-24 mm rear mount for 25-29 mm rear mount for 30-34 mm rear mount for 35-39 mm rear mount	Disc Brake (MANDATORY)
Oil	100 ml 250 ml 1.000 ml	Disc Brake
Bleeding Kit	-	Disc Brake
140 mm to 160 mm Rear Caliper adapter	-	Disc Brake
Chain Guard	for braze-on for ø 32/35 clamp	Accessory
Front Derailleur Clamp	ø 32 mm ø 35 mm	Accessory
Front Derailleur barrel adjuster	-	Accessory
RECORD™ Headset	-	General
RECORD™ front hub	-	General
RECORD™ rear hub	-	General

TECH DATA

SUPER RECORD™
12x2 SPEED™

RIM BRAKE

COMPONENT	OPTIONS	WEIGHT [g]	WEIGHT REFERENCE
SUPER RECORD™ rear derailleur	compatible with sprocket sets 11-29, 11-32, 11-34	181	standard hanger version
SUPER RECORD™ Ergopower™ controls	-	339	Pair
SUPER RECORD™ front derailleur	-	79	-
SUPER RECORD™ crankset	165 mm 170 mm 172,5 mm 175 mm 39-53 36-52 34-50	618	172,5 mm, 34-50 (2 bearings assembled)
SUPER RECORD™ ULTRA-TORQUE™ threaded cups	ITA: 70x (36x24 tpi) BSA: 68x (1,37"x24 tpi)	43	BSA
ULTRA-TORQUE™ press-fit cups	BB30: (68x42) mm BB86: (86,5x41) mm PF30: (68x46) mm BB386: (86,5x46) mm BB RIGHT: (79x46) mm BB30A: (73x42) mm	40	BB86
SUPER RECORD™ sprockets	11-29 11-32 11-34	266	11-29
SUPER RECORD™ chain	-	220	110 links
SUPER RECORD™ brakes	-	311	Pair
CAMPAGNOLO® direct mount brake	Front Rear Seat Stay	168	1 piece
COMPLETE GROUPSET		2.062	

EXTRA COMPONENTS	OPTIONS	CATEGORY
RECORD™ direct mount brake	Rear Under BB	Brakes
Chain Guard	for braze-on for ø 32/35 clamp	Accessory
Front Derailleur Clamp	ø 32 mm ø 35 mm	Accessory
Front Derailleur barrel adjuster	-	Accessory
RECORD™ Headset	-	General
RECORD™ front hub	-	General
RECORD™ rear hub	-	General

GROUPSETS



DISC BRAKE

COMPONENT	OPTIONS	WEIGHT [g]	WEIGHT REFERENCE
RECORD™ rear derailleur	compatible with sprocket sets 11-29, 11-32, 11-34	216	standard hanger version
RECORD™ Ergopower™ DB controls	-	462	-
RECORD™ front derailleur	-	81	-
RECORD™ crankset	165 mm 170 mm 172,5 mm 175 mm 39-53 36-52 34-50	708	170 mm, 34-50 (2 bearings assembled)
RECORD™ ULTRA-TORQUE™ threaded cups	ITA: 70x (36x24 tpi) BSA: 68x (1,37"x24 tpi)	45	BSA
ULTRA-TORQUE™ press-fit cups	BB30: (68x42) mm BB86: (86,5x41) mm PF30: (68x46) mm BB386: (86,5x46) mm BB RIGHT: (79x46) mm BB30A: (73x42) mm	40	BB86
SUPER RECORD™ sprockets	11-29 11-32 11-34	266	11-29
SUPER RECORD™ chain	-	220	110 links
CAMPAGNOLO® caliper	160 mm Front 160 mm Rear 140 mm	118	140 mm (1 piece - pads included)
CAMPAGNOLO® 03 rotor	160 mm 140 mm	99	140 mm (1 piece)
COMPLETE GROUPSET		2.454	2 calipers 2 rotors

EXTRA COMPONENTS	OPTIONS	CATEGORY
Rear Caliper Bolts	for 10-14 mm rear mount for 15-19 mm rear mount for 20-24 mm rear mount for 25-29 mm rear mount for 30-34 mm rear mount for 35-39 mm rear mount	Disc Brake (MANDATORY)
Oil	100 ml 250 ml 1.000 ml	Disc Brake
Bleeding Kit	-	Disc Brake
140 mm to 160 mm Rear Caliper adapter	-	Disc Brake
Chain Guard	for braze-on for ø 32/35 clamp	Accessory
Front Derailleur Clamp	ø 32 mm ø 35 mm	Accessory
Front Derailleur barrel adjuster	-	Accessory
RECORD™ Headset	-	General
RECORD™ front hub	-	General
RECORD™ rear hub	-	General

TECH DATA



RIM BRAKE

COMPONENT	OPTIONS	WEIGHT [g]	WEIGHT REFERENCE
RECORD™ rear derailleur	compatible with sprocket sets 11-29, 11-32, 11-34	216	standard hanger version
RECORD™ Ergopower™ controls	-	343	-
RECORD™ front derailleur	-	81	-
RECORD™ crankset	165 mm 170 mm 172,5 mm 175 mm 39-53 36-52 34-50	708	170 mm, 34-50 (2 bearings assembled)
RECORD™ ULTRA-TORQUE™ threaded cups	ITA: 70x (36x24 tpi) BSA: 68x (1,37"x24 tpi)	45	BSA
ULTRA-TORQUE™ press-fit cups	BB30: (68x42) mm BB86: (86,5x41) mm PF30: (68x46) mm BB386: (86,5x46) mm BB RIGHT: (79x46) mm BB30A: (73x42) mm	40	BB86
SUPER RECORD™ sprockets	11-29 11-32 11-34	266	11-29
SUPER RECORD™ chain	-	220	110 links
RECORD™ brakes	-	326	Pair
CAMPAGNOLO® direct mount brake	Front Rear Seat Stay	168	1 piece
COMPLETE GROUPSET		2.200	

EXTRA COMPONENTS	OPTIONS	CATEGORY
RECORD™ direct mount brake	Rear Under BB	Brakes
Chain Guard	for braze-on for ø 32/35 clamp	Accessory
Front Derailleur Clamp	ø 32 mm ø 35 mm	Accessory
Front Derailleur barrel adjuster	-	Accessory
RECORD™ Headset	-	General
RECORD™ front hub	-	General
RECORD™ rear hub	-	General

GROUPSETS

CHORUS™
12x2 SPEED™

DISC BRAKE

COMPONENT	OPTIONS	WEIGHT [g]	WEIGHT REFERENCE
CHORUS™ rear derailleur	-	220	standard hanger version
CHORUS™ Ergopower™ DB controls	-	488	Pair
CHORUS™ front derailleur	-	87	-
CHORUS™ crankset	165 mm, 170 mm, 172,5 mm, 175 mm 36-52, 34-50, 32-48	728	172,5 mm, 32-48 (2 bearings assembled)
RECORD™ ULTRA-TORQUE™ threaded cups	ITA: 70x (36x24 tpi) BSA: 68x (1,37"x24 tpi)	45	BSA
ULTRA-TORQUE™ press-fit cups	BB30: (68x42) mm BB86: (86,5x41) mm PF30: (68x46) mm BB386: (86,5x46) mm BB RIGHT: (79x46) mm BB30A: (73x42) mm	40	BB86
CHORUS™ sprockets	11-29 11-32 11-34	310	11-29
CHORUS™ chain	-	243	110 links
CAMPAGNOLO® caliper	160 mm Front 160 mm Rear 140 mm Rear	118	140 mm Rear (1 piece - pads included)
CAMPAGNOLO® rotor	160 mm 140 mm	99	140 mm (1 piece)
COMPLETE GROUPSET		2.605	2 calipers 2 rotors

EXTRA COMPONENTS	OPTIONS	CATEGORY
Rear Caliper Bolts	for 10-14 mm rear mount for 15-19 mm rear mount for 20-24 mm rear mount for 25-29 mm rear mount for 30-34 mm rear mount for 35-39 mm rear mount	Disc Brake (MANDATORY)
Oil	100 ml, 250 ml, 1.000 ml	Disc Brake
Bleeding Kit	-	Disc Brake
140 mm to 160 mm Rear Caliper adapter	-	Disc Brake
Chain Guard	for braze-on for ø 32/35 clamp	Accessory
Front Derailleur Clamp	ø 32 mm ø 35 mm	Accessory
Front Derailleur cable deviator insert	-	Accessory
Front Derailleur barrel adjuster	-	Accessory
RECORD™ Headset	-	General
RECORD™ front hub	-	General
RECORD™ rear hub	-	General

TECH DATA

CHORUS™
12x2 SPEED™

RIM BRAKE

COMPONENT	OPTIONS	WEIGHT [g]	WEIGHT REFERENCE
CHORUS™ rear derailleur	-	220	standard hanger version
CHORUS™ Ergopower™ controls	-	362	Pair
CHORUS™ front derailleur	-	87	-
CHORUS™ crankset	165 mm, 170 mm, 172,5 mm, 175 mm 36-52, 34-50, 32-48	728	172,5 mm, 32-48 (2 bearings assembled)
RECORD™ ULTRA-TORQUE™ threaded cups	ITA: 70x (36x24 tpi) BSA: 68x (1,37"x24 tpi)	45	BSA
ULTRA-TORQUE™ press-fit cups	BB30: (68x42) mm BB86: (86,5x41) mm PF30: (68x46) mm BB386: (86,5x46) mm BB RIGHT: (79x46) mm BB30A: (73x42) mm	40	BB86
CHORUS™ sprockets	11-29 11-32 11-34	310	11-29
CHORUS™ chain	-	243	110 links
CHORUS™ brakes	-	318	Pair
DIRECT™ direct mount brake	Front Rear Seat Stay	183	1 piece
COMPLETE GROUPSET		2.308	

EXTRA COMPONENTS	OPTIONS	CATEGORY
Chain Guard	for braze-on for ø 32/35 clamp	Accessory
Front Derailleur Clamp	ø 32 mm ø 35 mm	Accessory
Front Derailleur cable deviator insert	-	Accessory
Front Derailleur barrel adjuster	-	Accessory
RECORD™ Headset	-	General
RECORD™ front hub	-	General
RECORD™ rear hub	-	General

CENTAUR™

RIM BRAKE

COMPONENT	OPTIONS	WEIGHT [g]	WEIGHT REFERENCE
CENTAUR™ rear derailleur	-	230	short cage
CENTAUR™ Ergopower™ controls	-	373	Pair
CENTAUR™ front derailleur	-	103	-
CENTAUR™ crankset	170 mm 172,5 mm 175 mm 36-52 34-50	875	170 mm, 34-50 (2 bearings assembled)
RECORD™ ULTRA-TORQUE™ threaded cups	ITA: 70x (36x24 tpi) BSA: 68x (1,37"x24 tpi)	45	BSA
ULTRA-TORQUE™ press-fit cups	BB30: (68x42) mm BB86: (86,5x41) mm PF30: (68x46) mm BB386: (86,5x46) mm BB RIGHT: (79x46) mm BB30A: (73x42) mm	40	BB86
CENTUAR sprockets	11-29 11-32 12-32	291	11-29
CAMPAGNOLO 11™ chain	-	256	114 links
CENTAUR™ brakes	-	325	Pair
DIRECT™ direct mount brake	Front Rear Seat Stay	183	1 piece
COMPLETE GROUPSET		2.493	

EXTRA COMPONENTS	OPTIONS	CATEGORY
Chain Guard	for braze-on for ø 32/35 clamp	Accessory
Front Derailleur Clamp	ø 32 mm ø 35 mm	Accessory
Front Derailleur cable deviator insert	-	Accessory
Front Derailleur barrel adjuster	-	Accessory
RECORD™ Headset	-	General
RECORD™ front hub	-	General
RECORD™ rear hub	-	General
SUPER RECORD™ Bottle cage	-	General
SUPER RECORD™ Bottle	550 ml 750 ml thermal	General
RECORD™ front hub	-	General
RECORD™ rear hub	-	General

INTEGRATED CUPS

Uniquely compatible with all the frames on the market.

Thanks to accurate design that meets client needs, Campagnolo® cranksets can in fact be fitted to any type of frame: from the standard Italian to English types, to Press-Fit bottom brackets of BB86 86.5x41, BB30 68x42, PF30 68x46, BB386 86.5x46, BB30 68x42, BB30A 73x42 and BB RIGHT 79x46 with new design to improve coupling with Press-Fit bottom brackets on the market.

This means the well-known advantages of stiffness, lightness and performance over time typical of Campagnolo® cranksets remain unaltered. This solution offers many advantages, one of which is the ability to change frames without having to purchase a new crankset. This allows Campagnolo® to maintain the tried, tested and proven geometries and designs of the Ultra-Torque™ crankset without having to modify the crankset itself for the wide array of standards available currently.

Campagnolo®'s integrated cups, available for Ultra-Torque™ cranksets, have the same functionality as other systems but with the added technical advantage of maintaining the widest stance possible for the bearings. This reduces lateral forces acting on the bearings and makes for a smoother and more reactive performance that is more durable over time.

ULTRA TORQUE™	THREAD	
	ITA	BSA
	70x (36x24 tpi)	68x (1,37"x24 tpi)
<i>SUPER RECORD™</i>		
	OC12-SRI	OC12-SRG
<i>RECORD™</i>		
<i>CHORUS™</i>		
<i>CENTAUR™</i>		
	OC12-REI	OC12-REG

ULTRA TORQUE™	PRESS-FIT					
	BB30	BB30A	BB86	PF30	BB RIGHT	BB386
	68x42	73x42	86,5x41	68x46	79x46	86,5x46
<i>SUPER RECORD™</i>						
<i>RECORD™</i>						
<i>CHORUS™</i>						
<i>CENTAUR™</i>						
	IC15-RE42	IC19-UT73	IC15-RE41	IC15-RE46	IC15-UTR51E	IC15-UT386

TRIATHLON / TIME-TRIAL

12x2 SPEED™

EXTRA COMPONENTS	OPTIONS	CATEGORY
SUPER RECORD™ TT EPS™ shifting levers	-	98 Pair
SUPER RECORD™ TT EPS™ brake levers	-	110 Pair
TT EPS™ disc brake levers	-	448 Pair
TT DTI™ EPST™ V4 interface	-	45 cables included

WHEELS

ROAD - RIM BRAKE

NOMINAL WEIGHT (g)*	RIM MATERIAL	RIM SECTION: HEIGHT/WIDTH - mm (NOMINAL)	ULTRA-FIT™	LABELS	REQUIRES RIM TAPE	RIM FINISHING	NUMBER OF SPOKES
---------------------	--------------	--	------------	--------	-------------------	---------------	------------------

TECH DATA

DYNAMIC BALANCE	SPOKES MATERIAL	SPOKE TYPE	DIFFERENTIAL SPOKES RL	NUT/NIPPLE MATERIAL	O.L.D. (mm)	HUB BODY MATERIAL	CUPS & CONES BEARINGS	BEARINGS VERSION	HUB FINISHING	SPOKE ANTI-ROTATION SYSTEM	COMPATIBILITY
-----------------	-----------------	------------	------------------------	---------------------	-------------	-------------------	-----------------------	------------------	---------------	----------------------------	---------------

PERFORMANCE/AERO CARBON WHEELS

BORA™ ULTRA™ TT rear tub.	864	carbon	D/20		B	carb			carbon		130	alu	•	C	black		9/10/11/12	
BORA™ ULTRA™ TT rear tub. (HG)	864	carbon	D/20		B	carb			carbon		130	alu	•	C	black		9/10/11/12	
BORA™ WTO 77 2-Way Fit™ front	755	carbon	77/26,5	•	B	UD	16		RDB	SS	UAE DB	alu	100	alu	•	C	black	•
BORA™ WTO 60 2-Way Fit™ front	688	carb	60/26,5	•	B/D	UD	18		RDB	SS	UAE DB	alu	100	alu	•	U	black	•
BORA™ WTO 60 2-Way Fit™ rear	859	carb	60/26,5	•	B/D	UD	21/G3™		RDB	SS	UAE DB	alu	130	alu	•	U	black	•
BORA™ WTO 60 2-Way Fit™ rear (HG)	859	carb	60/26,5	•	B/D	UD	21/G3™		RDB	SS	UAE DB	alu	130	alu	•	U	black	•
BORA™ WTO 45 2-Way Fit™ front	657	carb	45/26,5	•	B/D	UD	18		RDB	SS	UAE DB	alu	100	alu	•	U	black	•
BORA™ WTO 45 2-Way Fit™ rear	839	carb	45/26,5	•	B/D	UD	21/G3™		RDB	SS	UAE DB	alu	130	alu	•	U	black	•
BORA™ WTO 45 2-Way Fit™ rear (HG)	839	carb	45/26,5	•	B/D	UD	21/G3™		RDB	SS	UAE DB	alu	130	alu	•	U	black	•
BORA™ WTO 33 2-Way Fit™ front	593	carb	33/26,5	•	B/D	UD	18		RDB	SS	UAE DB	alu	100	alu	•	U	black	•
BORA™ WTO 33 2-Way Fit™ rear	795	carb	33/26,5	•	B/D	UD	21/G3™		RDB	SS	UAE DB	alu	130	alu	•	U	black	•
BORA™ WTO 33 2-Way Fit™ rear (HG)	795	carb	33/26,5	•	B/D	UD	21/G3™		RDB	SS	UAE DB	alu	130	alu	•	U	black	•

KEY

DB=Butted - AE=Aero - UAE=Ultra Aero - SS=Stainless steel - BR=Brass - S=steel - U=USB™ - C=CULT™ - SDB=Spoke Dynamic Balance - RDB=Rim Dynamic Balance
 B=Bright - D=Dark - BLK SAT=black satinized

* Average weight - does not include the quick-release and the rim-tape - wheel weight may vary depending on the tolerance of the production process.

WHEELS

TECH DATA

ROAD - RIM BRAKE

	NOMINAL WEIGHT [g]*	RIM MATERIAL	RIM SECTION: HEIGHT/WIDTH - mm (NOMINAL)	ULTRA-FIT™	LABELS	REQUIRES RIM TAPE	RIM FINISHING	NUMBER OF SPOKES	DYNAMIC BALANCE	SPOKES MATERIAL	SPOKE TYPE	DIFFERENTIAL SPOKES R/L	NIPPLE MATERIAL	O.L.D. [mm]	HUB BODY MATERIAL	CUPS & CONES BEARINGS	BEARINGS VERSION	HUB FINISHING	SPOKE ANTI-ROTATION SYSTEM	COMPATIBILITY
--	---------------------	--------------	--	------------	--------	-------------------	---------------	------------------	-----------------	-----------------	------------	-------------------------	-----------------	-------------	-------------------	-----------------------	------------------	---------------	----------------------------	---------------

ALUMINIUM WHEELS

SHAMAL™ ULTRA™ front cl.	623	alu	24-27/22		B	black	16		RDB	alu	AE DB	alu	100	alu/carb	•	U	blk/carb	•		
SHAMAL™ ULTRA™ rear cl.	826	alu	27-30/22		B	black	21/G3™		RDB	alu	AE DB	alu	130	alu/carb	•	U	blk/carb	•		9/10/11/12
SHAMAL™ ULTRA™ rear cl. (HG)	826	alu	27-30/22		B	black	21/G3™		RDB	alu	AE DB	alu	130	alu/carb	•	U	blk/carb	•		9/10/11/12
SHAMAL™ ULTRA™ 2-Way Fit™ front	641	alu	24-27/22	•	B	black	16		RDB	alu	AE DB	alu	100	alu/carb	•	U	blk/carb	•		
SHAMAL™ ULTRA™ 2-Way Fit™ rear	834	alu	27-30/22	•	B	black	21/G3™		RDB	alu	AE DB	alu	130	alu/carb	•	U	blk/carb	•		9/10/11/12
SHAMAL™ ULTRA™ 2-Way Fit™ rear (HG)	834	alu	27-30/22	•	B	black	21/G3™		RDB	alu	AE DB	alu	130	alu/carb	•	U	blk/carb	•		9/10/11/12
ZONDA™ front cl.	678	alu	24-27/22		B	black	16		RDB	SS	AE DB	BR	100	alu	•	S	black	•		
ZONDA™ rear cl.	862	alu	27-30/22		B	black	21/G3™		RDB	SS	AE DB	BR	130	alu	•	S	black	•		9/10/11/12
ZONDA™ rear cl. (HG)	862	alu	27-30/22		B	black	21/G3™		RDB	SS	AE DB	BR	130	alu	•	S	black	•		9/10/11/12
SCIROCCO™ front cl.	820	alu	35/22		B	• black	16			SS	AE DB	alu	100	alu		S	black	•		
SCIROCCO™ rear cl.	935	alu	35/22		B	• black	21/G3™			SS	AE DB	alu	130	alu		S	black	•		9/10/11/12
SCIROCCO™ rear cl. (HG)	935	alu	35/22		B	• black	21/G3™			SS	AE DB	alu	130	alu		S	black	•		9/10/11/12
CALIMA™ front cl.	789	alu	24/22		B	• black	18			S		BR	100	alu		S	black			
CALIMA™ rear cl.	1037	alu	24/22		B	• black	27/G3™			S		BR	130	alu		S	black			9/10/11/12
CALIMA™ rear cl. (HG)	1089	alu	24/22		B	• black	27/G3™			S		BR	130	alu		S	black			9/10/11/12

TRIATHLON - TIME TRIAL

BORA™ ULTRA™ TT rear tub.	864	carbon	D/20		B	carb				carbon			130	alu	•	C	black			9/10/11/12
BORA™ ULTRA™ TT rear tub. (HG)	864	carbon	D/20		B	carb				carbon			130	alu	•	C	black			9/10/11/12

PISTA

GHIBLI™ front tub. track	800	carb	D/20										100	alu	•	C				
GHIBLI™ front tub. track	810	carb	D/20										65	alu	•	C				
GHIBLI™ rear tub. track	825	carb	D/20										120	alu	•	C				
BORA™ ULTRA™ 80 front tub. track	705	carb	80/20		B	carb	16		RDB	SS	AE DB	alu	100	carb	•	C	blk/carb	•		

KEY

DB=Butted - AE=Aero - UAE=Ultra Aero - SS=Stainless steel - BR=Brass - S=steel - U=USB™ - C=CULT™ - SDB=Spoke Dynamic Balance - RDB=Rim Dynamic Balance
 B=Bright - D=Dark - BLK SAT=black satinized

* Average weight - does not include the quick-release and the rim-tape - wheel weight may vary depending on the tolerance of the production process.

WHEELS

TECH DATA

ROAD - DISC BRAKE

NOMINAL WEIGHT (g)*	RIM MATERIAL	RIM SECTION: HEIGHT/WIDTH - mm (NOMINAL)	ULTRA-FIT™	LABELS	REQUIRES RIM TAPE	RIM FINISHING	NUMBER OF SPOKES	DYNAMIC BALANCE	SPOKES MATERIAL	SPOKE TYPE	DIFFERENTIAL SPOKES R/L	NIPPLE MATERIAL	O.L.D. (mm)	HUB BODY MATERIAL	CUPS & CONES BEARINGS	BEARINGS VERSION	HUB FINISHING	SPOKE ANTI-ROTATION SYSTEM	COMPATIBILITY
---------------------	--------------	--	------------	--------	-------------------	---------------	------------------	-----------------	-----------------	------------	-------------------------	-----------------	-------------	-------------------	-----------------------	------------------	---------------	----------------------------	---------------

PERFORMANCE/AERO CARBON WHEELS

BORA™ ULTRA™ WTO TT DB rear 2-Way Fit (N3W)	930	carbon	D/20		B	carb													11/12/13
BORA™ ULTRA™ WTO TT DB rear 2-Way Fit (HG)	928	carbon	D/20		B	carb			carbon				130	alu	•	C	black		9/10/11/12
BORA™ ULTRA™ WTO TT DB rear 2-Way Fit (XDR)	916	carbon	D/20		B	carb			carbon				130	alu	•	C	black		12
BORA™ ULTRA WTO 80 DB 2-Way Fit front	740	carb	80/26,1	•	D	UD	24/G3™	RDB	SS	UAE DB		alu	100	carb	•	C	blk/carb	•	
BORA™ ULTRA WTO 80 DB 2-Way Fit rear (N3W)	855	carb	80/26,1	•	D	UD	24/G3™	RDB	SS	UAE DB		alu	142	alu	•	C	black	•	11/12/13
BORA™ ULTRA WTO 80 DB 2-Way Fit rear (HG)	853	carb	80/26,1	•	D	UD	24/G3™	RDB	SS	UAE DB		alu	142	alu	•	C	black	•	9/10/11/12
BORA™ ULTRA WTO 80 DB 2-Way Fit rear (XDR)	851	carb	80/26,1	•	D	UD	24/G3™	RDB	SS	UAE DB		alu	142	alu	•	C	black	•	12
BORA™ ULTRA WTO 60 DB 2-Way Fit front	710	carb	60/26,1	•	D	UD	24/G3™	RDB	SS	UAE DB		alu	100	carb	•	C	blk/carb	•	
BORA™ ULTRA WTO 60 DB 2-Way Fit rear (N3W)	820	carb	60/26,1	•	D	UD	24/G3™	RDB	SS	UAE DB		alu	142	alu	•	C	black	•	11/12/13
BORA™ ULTRA WTO 60 DB 2-Way Fit rear (HG)	818	carb	60/26,1	•	D	UD	24/G3™	RDB	SS	UAE DB		alu	142	alu	•	C	black	•	9/10/11/12
BORA™ ULTRA WTO 60 DB 2-Way Fit rear (XDR)	806	carb	60/26,1	•	D	UD	24/G3™	RDB	SS	UAE DB		alu	142	alu	•	C	black	•	12
BORA™ ULTRA WTO 45 DB 2-Way Fit front	660	carb	45/26,1	•	D	UD	24/G3™	RDB	SS	UAE DB		alu	100	carb	•	C	blk/carb	•	
BORA™ ULTRA WTO 45 DB 2-Way Fit rear (N3W)	765	carb	45/26,1	•	D	UD	24/G3™	RDB	SS	UAE DB		alu	142	alu	•	C	black	•	11/12/13
BORA™ ULTRA WTO 45 DB 2-Way Fit rear (HG)	763	carb	45/26,1	•	D	UD	24/G3™	RDB	SS	UAE DB		alu	142	alu	•	C	black	•	9/10/11/12
BORA™ ULTRA WTO 45 DB 2-Way Fit rear (XDR)	751	carb	45/26,1	•	D	UD	24/G3™	RDB	SS	UAE DB		alu	142	alu	•	C	black	•	12
BORA™ ULTRA WTO 33 DB 2-Way Fit front	640	carb	33/27,4	•	D	UD	24/G3™	RDB	SS	UAE DB		alu	100	carb	•	C	blk/carb	•	
BORA™ ULTRA WTO 33 DB 2-Way Fit rear (N3W)	745	carb	33/27,4	•	D	UD	24/G3™	RDB	SS	UAE DB		alu	142	alu	•	C	black	•	11/12/13
BORA™ ULTRA WTO 33 DB 2-Way Fit rear (HG)	743	carb	33/27,4	•	D	UD	24/G3™	RDB	SS	UAE DB		alu	142	alu	•	C	black	•	9/10/11/12
BORA™ ULTRA WTO 33 DB 2-Way Fit rear (XDR)	731	carb	33/27,4	•	D	UD	24/G3™	RDB	SS	UAE DB		alu	142	alu	•	C	black	•	12
BORA™ WTO 60 DB 2-Way Fit™ front	749	carb	60/26,1	•	D	UD	24/G3™	RDB	SS	UAE DB		alu	100	alu	•	U	black	•	
BORA™ WTO 60 DB 2-Way Fit™ rear	841	carb	60/26,1	•	D	UD	24/G3™	RDB	SS	UAE DB		alu	142	alu	•	U	black	•	9/10/11/12
BORA™ WTO 60 DB 2-Way Fit™ rear (HG)	844	carb	60/26,1	•	D	UD	24/G3™	RDB	SS	UAE DB		alu	142	alu	•	U	black	•	9/10/11/12
BORA™ WTO 60 DB 2-Way Fit™ rear (XDR)	832	carb	60/26,1	•	D	UD	24/G3™	RDB	SS	UAE DB		alu	142	alu	•	U	black	•	12
BORA™ WTO 45 DB 2-Way Fit™ front	708	carb	45/26,5	•	D	UD	24/G3™	RDB	SS	UAE DB		alu	100	alu	•	U	black	•	
BORA™ WTO 45 DB 2-Way Fit™ rear	812	carb	45/26,5	•	D	UD	24/G3™	RDB	SS	UAE DB		alu	142	alu	•	U	black	•	9/10/11/12
BORA™ WTO 45 DB 2-Way Fit™ rear (HG)	812	carb	45/26,5	•	D	UD	24/G3™	RDB	SS	UAE DB		alu	142	alu	•	U	black	•	9/10/11/12
BORA™ WTO 45 DB 2-Way Fit™ rear (XDR)	805	carb	45/26,5	•	D	UD	24/G3™	RDB	SS	UAE DB		alu	142	alu	•	U	black	•	12
BORA™ WTO 33 DB 2-Way Fit™ front	675	carb	33/26,1	•	D	UD	24/G3™	RDB	SS	UAE DB		alu	100	alu	•	U	black	•	
BORA™ WTO 33 DB 2-Way Fit™ rear	775	carb	33/26,1	•	D	UD	24/G3™	RDB	SS	UAE DB		alu	142	alu	•	U	black	•	9/10/11/12
BORA™ WTO 33 DB 2-Way Fit™ rear (HG)	775	carb	33/26,1	•	D	UD	24/G3™	RDB	SS	UAE DB		alu	142	alu	•	U	black	•	9/10/11/12
BORA™ WTO 33 DB 2-Way Fit™ rear (XDR)	768	carb	33/26,1	•	D	UD	24/G3™	RDB	SS	UAE DB		alu	142	alu	•	U	black	•	12

KEY

DB=Butted - AE=Aero - UAE=Ultra Aero - SS=Stainless steel - BR=Brass - S=steel - U=USB™ - C=CULT™ - SDB=Spoke Dynamic Balance - RDB=Rim Dynamic Balance
 B=Bright - D=Dark - BLK SAT=black satinized

* Average weight - does not include the quick-release and the rim-tape - wheel weight may vary depending on the tolerance of the production process.

WHEELS

ROAD - DISC BRAKE

NOMINAL WEIGHT (g)*	RIM MATERIAL	RIM SECTION: HEIGHT/WIDTH - mm (NOMINAL)	ULTRA-FIT™	LABELS	REQUIRES RIM TAPE	RIM FINISHING	NUMBER OF SPOKES
---------------------	--------------	--	------------	--------	-------------------	---------------	------------------

TECH DATA

DYNAMIC BALANCE	SPOKES MATERIAL	SPOKE TYPE	DIFFERENTIAL SPOKES R/L	NIPPLE MATERIAL	O.L.D. (mm)	HUB BODY MATERIAL	CUPS & CONES BEARINGS	BEARINGS VERSION	HUB FINISHING	SPOKE ANTI-ROTATION SYSTEM	COMPATIBILITY
-----------------	-----------------	------------	-------------------------	-----------------	-------------	-------------------	-----------------------	------------------	---------------	----------------------------	---------------

GRAVEL CARBON WHEELS

LEVANTE™ DB 2-Way Fit™ front	690	carb	30/30,6	•	-	UD	24	RDB	SS	AE DB	alu	100	alu	•	S	black	•	
LEVANTE™ DB 2-Way Fit™ rear (N3W)	795	carb	30/30,6	•	-	UD	24	RDB	SS	AE DB	alu	142	alu	•	S	black	•	11/12/13
LEVANTE™ DB 2-Way Fit™ rear (HG)	793	carb	30/30,6	•	-	UD	24	RDB	SS	AE DB	alu	142	alu	•	S	black	•	9/10/11/12
LEVANTE™ DB 2-Way Fit™ rear (XDR)	791	carb	30/30,6	•	-	UD	24	RDB	SS	AE DB	alu	142	alu	•	S	black	•	12

ENDURANCE CARBON WHEELS

SHAMAL™ CARBON DB 2-Way Fit™ front	723	carb	35/28,1	•	D	UD	24/G3™	RDB	SS	AE DB	alu	100	alu	•	S	black	•	
SHAMAL™ CARBON DB 2-Way Fit™ rear (N3W)	849	carb	40/28,1	•	D	UD	24/G3™	RDB	SS	AE DB	alu	142	alu	•	S	black	•	11/12/13
SHAMAL™ CARBON DB 2-Way Fit™ rear (HG)	852	carb	40/28,1	•	D	UD	24/G3™	RDB	SS	AE DB	alu	142	alu	•	S	black	•	9/10/11/12
SHAMAL™ CARBON DB 2-Way Fit™ rear (XDR)	841	carb	40/28,1	•	D	UD	24/G3™	RDB	SS	AE DB	alu	142	alu	•	S	black	•	12

ALUMINIUM WHEELS

ZONDA™ DB front cl.	786	alu	26-28/22		B	black	21/G3™	RDB	SS	AE DB	alu	100	alu	•	S	black	•	
ZONDA™ DB rear cl.	889	alu	26-28/22		B	black	21/G3™	RDB	SS	AE DB	alu	135-142	alu	•	S	black	•	9/10/11/12
ZONDA™ DB rear cl. (HG)	889	alu	26-28/22		B	black	21/G3™	RDB	SS	AE DB	alu	135-142	alu	•	S	black	•	9/10/11/12
SCIROCCO™ DB 2-Way Fit™ ready front	819	alu	33/24,2	•	B	•	black		SS		alu	100	alu		S	black		
SCIROCCO™ DB 2-Way Fit™ ready rear	920	alu	33/24,2	•	B	•	black		SS		alu	135-142	alu		S	black		9/10/11/12
SCIROCCO™ DB 2-Way Fit™ ready rear (HG)	920	alu	33/24,2	•	B	•	black		SS		alu	135-142	alu		S	black		9/10/11/12

KEY

DB=Butted - AE=Aero - UAE=Ultra Aero - SS=Stainless steel - BR=Brass - S=steel - U=USB™ - C=CULT™ - SDB=Spoke Dynamic Balance - RDB=Rim Dynamic Balance
B=Bright - D=Dark - BLK SAT=black satinized

* Average weight - does not include the quick-release and the rim-tape - wheel weight may vary depending on the tolerance of the production process.

CAMPAGNOLO® SERVICE CENTER

The Service Center is the reference point for all Campagnolo® dealers and its aim is to provide an adequate after-sales service to Campagnolo® users. Service Centers are a territorial extension of Campagnolo srl and work exclusively with dealers, no exceptions made. The Service Centers handle two activities: After-sales Service and Spare Parts Service.

The After-sales Service provides technical assistance for products under guarantee or otherwise, enabling cyclists to enjoy the first-class characteristics of Campagnolo® products for long, without forfeiting safety, performance and endurance. The Spare Parts Service handles the distribution of spare parts. Campagnolo® possesses a large inventory of spare parts and is able to replenish its distribution system adequately in relatively short times.

We therefore advise you to refer to your Campagnolo® dealer for any expert action required by your bikes - these dealers are the only ones supported by the constant, skilled collaboration of Campagnolo® Service Centers.

TECHNICAL INFORMATION

ITALY (CENTRAL) Tel. +39-0444-225600 Fax: +39-0444-225606	FRANCE Tel. +33-477-554449 Fax: +33-477-556345	GERMANY Tel. +49-214-206953-20 Fax: +49-214-206953-15
SPAIN Tel. +34-945-217195 Fax: +34-945-217198	U.S.A. Tel. +1-760-9310106 Fax: +1-760-9310991	JAPAN Tel. +81-45-264-2780 Fax: +81-45-241-8030



CAMPAGNOLO® SERVICE CENTER list at www.campagnolo.com/WW/en/Support/service_center



CAMPY CARE
NEED HELP?

Go to a Pro-Shop. They'll be able to offer you all the assistance you need.

[FIND THE NEAREST STORE >](#)

Didn't you find stores near your home?
Please contact the service center in your country.

CAMPAGNOLO® SALES NETWORK

HEADQUARTERS

CAMPAGNOLO S.R.L.
Via della Chimica, 4
36100 Vicenza - ITALY
Tel. +39-0444-225500
Fax: +39-0444-225400
E-mail: sales@campagnolo.com

BRANCH OFFICES

FRANCE
CAMPAGNOLO FRANCE SAS
ZA du Tissot
42530 St GENEST - LERPT
Tel. +33-477-556305
Fax: +33-477-556345
E-mail: campagnolo@campagnolo.fr

JAPAN
CAMPAGNOLO JAPAN LTD
65 Yoshidamachi, Naka-ku,
YOKOHAMA
231-0041
Tel. +81-45-264-2780
Fax: +81-45-241-8030
E-mail: info@campagnolo.jp

TAIWAN
PRIMATEK LTD
No. 1, Gongyequ 37th Rd.,
Xitun Dist.,
Taichung City 407, Taiwan R.O.C.
Tel. +886-4-23506831
Fax: +886-4-23596764

BRANCH OFFICES

GERMANY
CAMPAGNOLO DEUTSCHLAND
GMBH
Alte Garten 62
51371 LEVERKUSEN
Tel. +49-214-206953-0
Fax: +49-214-206953-15
E-mail: campagnolo@campagnolo.de

SPAIN
CAMPAGNOLO IBERICA S.L.
Avda. de Los Huetos 46.
Pab. 31 - 01010 VITORIA
Tel. +34-945-217195
Fax: +34-945-217198
E-mail: campagnolo@campagnolo.es

UNITED STATES
CAMPAGNOLO NORTH AMERICA
INC.
5431 Avenida Encinas, Suite C -
CARLSBAD CA 92008 - U.S.A.
Tel. +1-760-9310106
Fax: +1-760-9310991
E-mail: info@campagnolona.com

AGENT

BENELUX
INTERNATIONAL
CYCLE CONNECTION I.C.C.
Communicatielaan 5A
4538 BV TERNEUZEN
NETHERLAND
Tel. +31 (0)115 649321
Fax: +31 (0)115 649110
E-mail: info@i-c-c.nl
Web: www.i-c-c.nl



CAMPAGNOLO® SALES NETWORK list at www.campagnolo.com/WW/en/Support/sales_network



[FIND THE NEAREST STORE >](#)

Didn't you find stores near your home?
Please contact the service center in your country.

Campagnolo

CAMPAGNOLO S.R.L.

Via della Chimica, 4
36100 Vicenza - ITALY
Phone: +39 0444 225500
Fax: +39 0444 225400

www.campagnolo.com

Campagnolo®, Campy™, Super Record™, Record™, Chorus™, Athena™, Potenza 11™, EPS™, Ekar™, CT™, Centaur™, Veloce™, Mirage™, Xenon™, MyCampy™, MyGarage™, MyEPS™, MySessions™, ESP™, ESP™ ACTUATION SYSTEM™, Ultra-Shift™, Vari-Cushion™, No-Bulge™, OS-Fit™, Ultra-Link™, CULT™, USB™, XPS™, MPST™, Power Torque System™, Power Torque +™, Power-Shift™, Pro-Tech™, Embrace Technology™, S2 System™, CSD™, AMS™, BE 11™, Revolution 11™, Campy Tech Lab™, 2-Way Fit™, Ultra-Fit™ Tubeless, 3Diamant™, Hyperon™, Neutron™, Proton™, Eurus™, Zonda™, Scirocco™, Vento™, Vento Asymmetric™, Bora™, Ghibli™, Pista™, Khamsin™, Khamsin Asymmetric™, Calima™, Shamal™, Levante™, Bullet™, Time Trial™, Ergobrain™, Symmetric Action™, Z-shape™, M-brace™, Even-0™, Superlative™, Floating-Link-Action™, HD-Link™, HD-L™, Exa-Drive™, Ultra-Drive™, Pro-Fit™, Pro-Fit PLUS™, Differential brakes™, Threadless™, Hiddenset™, Hiddenset TTC™, TTC™, Ergopower™, BB System™, C10™, C9™, ED™, UD™, Ultra Narrow™, Over-Torque™, UT™, Ultra-Torque™, Over-Torque™ Technology, Ultra-Hollow™, Skeleton™, Quick Shift™, QS™, Escape™, Infinite™, Champ Triple™, Race Triple™, Comp Triple™, HPW™, Mega-G3™, G3™, Grouped Spokes™, DPRO™, Dual Profile™, Ultralinear-Geometry™, Ultralinear™, Differential rims™, Differential spokes™, Ultra™, Ultra Aero™, DRSC™, RDB™, Spokes Anti-Rotation System™, Spoke Dynamic Balance™, AC3™, N3W™, Comp Ultra™, Comp One™, 3Diamant™, Dynamic Balance™, Full Carbon™, Multidirectional™, Unidirectional™, AC-H™, AC-S™, SC-S™, Big™, Miro™, Pro-Shop™, Tecnologia ed Emozione™, Pure Performance™, are Campagnolo Srl trademarks.

QR Code® is registered trademarks of DENSO WAVE INCORPORATED.
Copyright(C) 2000-2010
DENSO WAVE INCORPORATED
All right reserved

Credits:

Racing photos: © Getty Images
© Poci's
© www.jamesheadle.com





#DREAMBIGGER
CAMPAGNOLO.COM